

## CH 系列 IC 常用封装尺寸

版本: 3B

<http://wch.cn>

封装	页码
DIP8	3
DIP14	4
DIP16	5
DIP18	6
DIP20	7
DIP24S/SKDIP24/DIP24-300mil	8
DIP28S/SKDIP28/DIP28-300mil	9
DIP28/DIP28W/DIP28-600mil	10
SDIP28/SDIP28-400mil	11
SDIP32/SDIP32-400mil	12
SOP8、eSOP8	13
SOP14	14
SOP16/SOP16-150mil	15
SOP18	16
SOP20	17
SOP24	18
SOP28	19
SOP30	20
SSOP10/SSOP10-150mil-1.00、eSSOP10	21
SSOP16/SSOP16-209mil-0.65	22
SSOP20/SSOP20-209mil-0.65	23
SSOP24/SSOP24-209mil-0.65	24
SSOP28/SSOP28-209mil-0.65	25
MSOP10	26
TSSOP8	27
TSSOP14、eTSSOP14	28
TSSOP16、eTSSOP16	29
TSSOP20、eTSSOP20	30
TSSOP24	31
TSSOP28	32
QSOP16/SSOP16-150mil-0.635	33
QSOP20/SSOP20-150mil-0.635	34
QSOP24/SSOP24-150mil-0.635	35
QSOP28/SSOP28-150mil-0.635	36
PQFP44/QFP44	37
PQFP52/QFP52	38
PQFP64/QFP64、LQFP64-14*14	39
PQFP80/QFP80	40
LQFP32/LQFP32-7*7	41
LQFP44/LQFP44-10*10	42
LQFP48/LQFP48-7*7、TQFP48、eLQFP48	43

LQFP64/LQFP64-7*7、TQFP64	.....	44
LQFP64M/LQFP64-10*10	.....	45
LQFP80/LQFP80-12*12	.....	46
LQFP100/LQFP100-14*14	.....	47
LQFP128/LQFP128-14*14	.....	48
LQFP144/LQFP144-20*20	.....	49
QFN12/QFN12-2*2	.....	50
QFN16/QFN16-3*3	.....	51
QFN16X4/QFN16-4*4	.....	52
QFN20/QFN20-3*3	.....	53
QFN20X4/QFN20-4*4	.....	54
QFN20-2.5*4.5	.....	55
QFN24/QFN24-4*4	.....	56
QFN24-3*3.5	.....	57
QFN28/QFN28-4*4	.....	58
QFN28X5/QFN28-5*5	.....	59
QFN32/QFN32-4*4	.....	60
QFN32X5/QFN32-5*5	.....	61
QFN36X6/QFN36-6*6	.....	62
QFN40/QFN40-5*5	.....	63
QFN40X6/QFN40-6*6	.....	64
QFN42-3.5*9	.....	65
QFN48/QFN48-5*5	.....	66
QFN48X6/QFN48-6*6	.....	67
QFN48X7/QFN48-7*7	.....	68
QFN68X8/QFN68-8*8	.....	69
SOT23-6、TSOT23-6L	.....	70
SOT23-8、TSOT23-8L	.....	71
SOT363/SC70-6L	.....	72
SOT353/SC70-5L	.....	73

说明：所有尺寸标注的单位都是 mm（毫米），  
引脚中心间距总是标称值，没有误差；  
除此之外的尺寸误差不大于±0.2mm 或者±10%两者中的较大值。

DIP 类 (PDIP)

DIP8

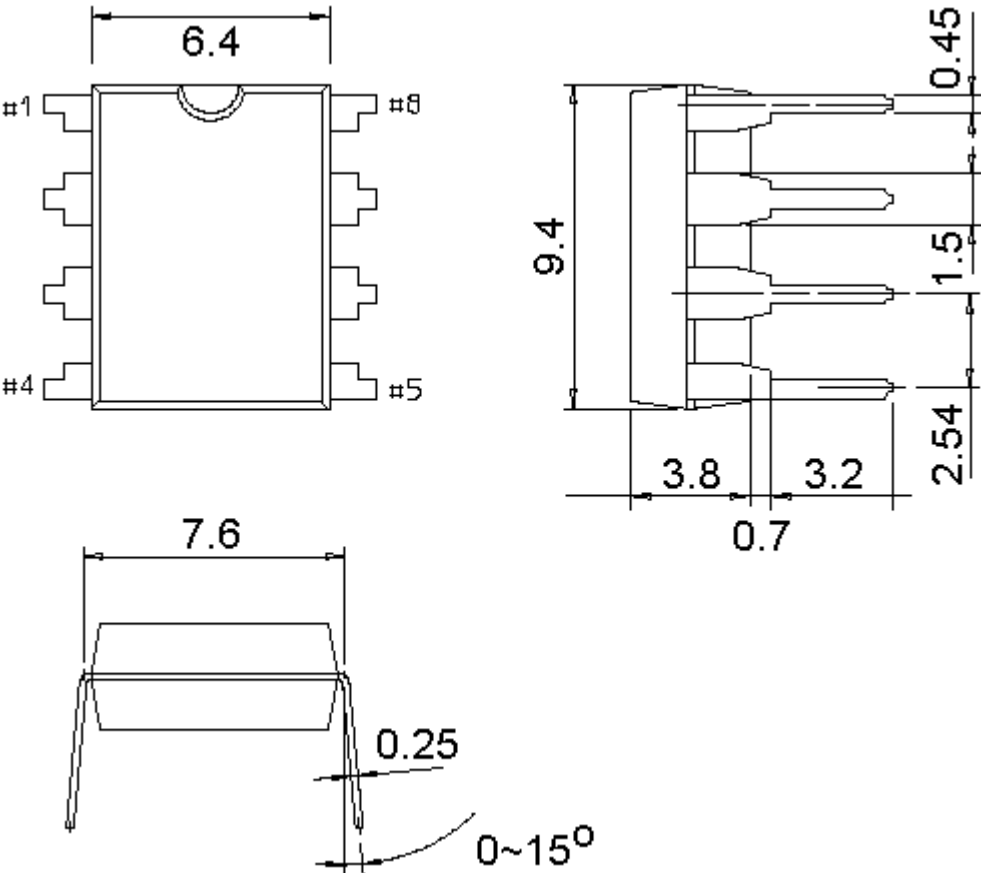

DIP14

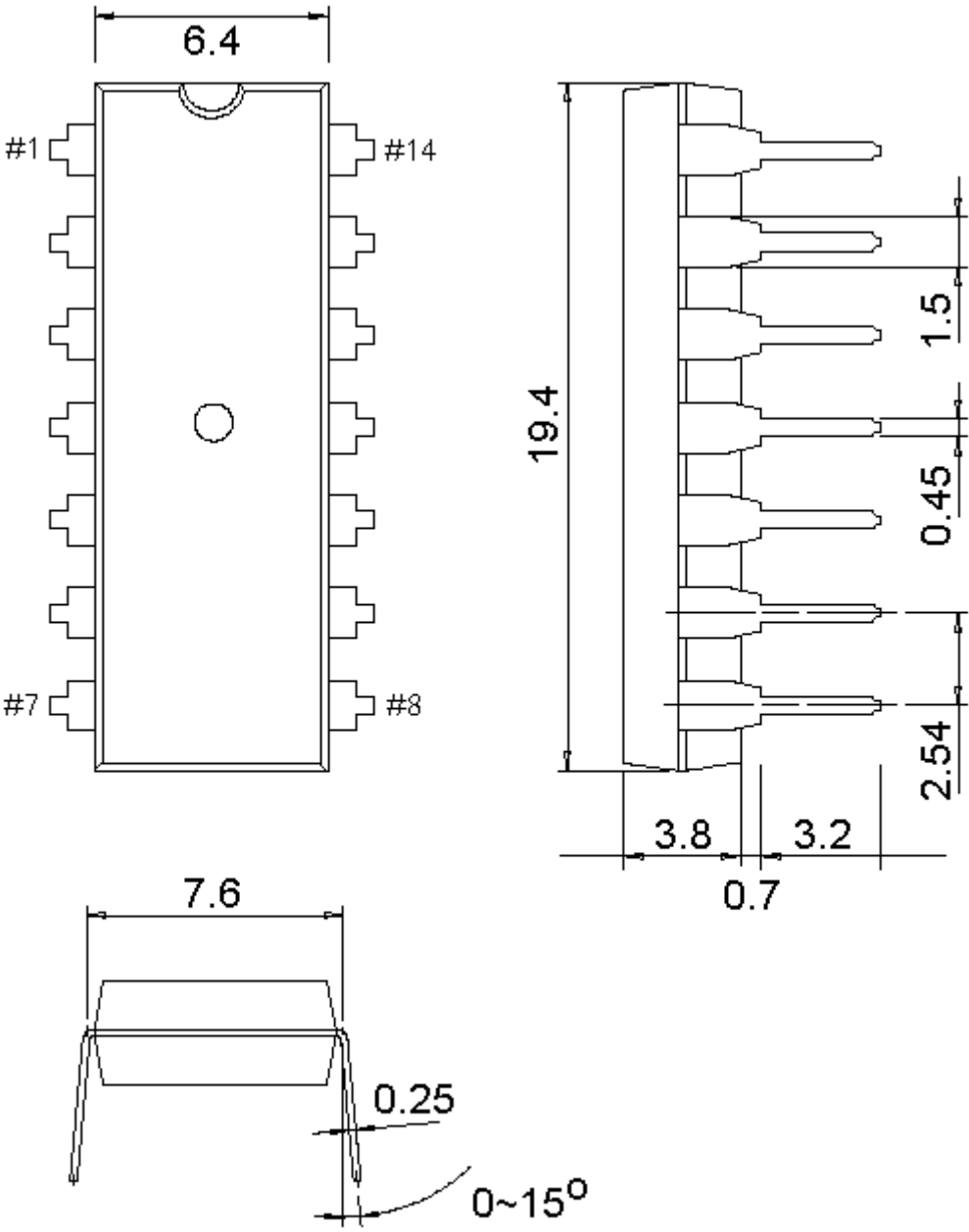

DIP16

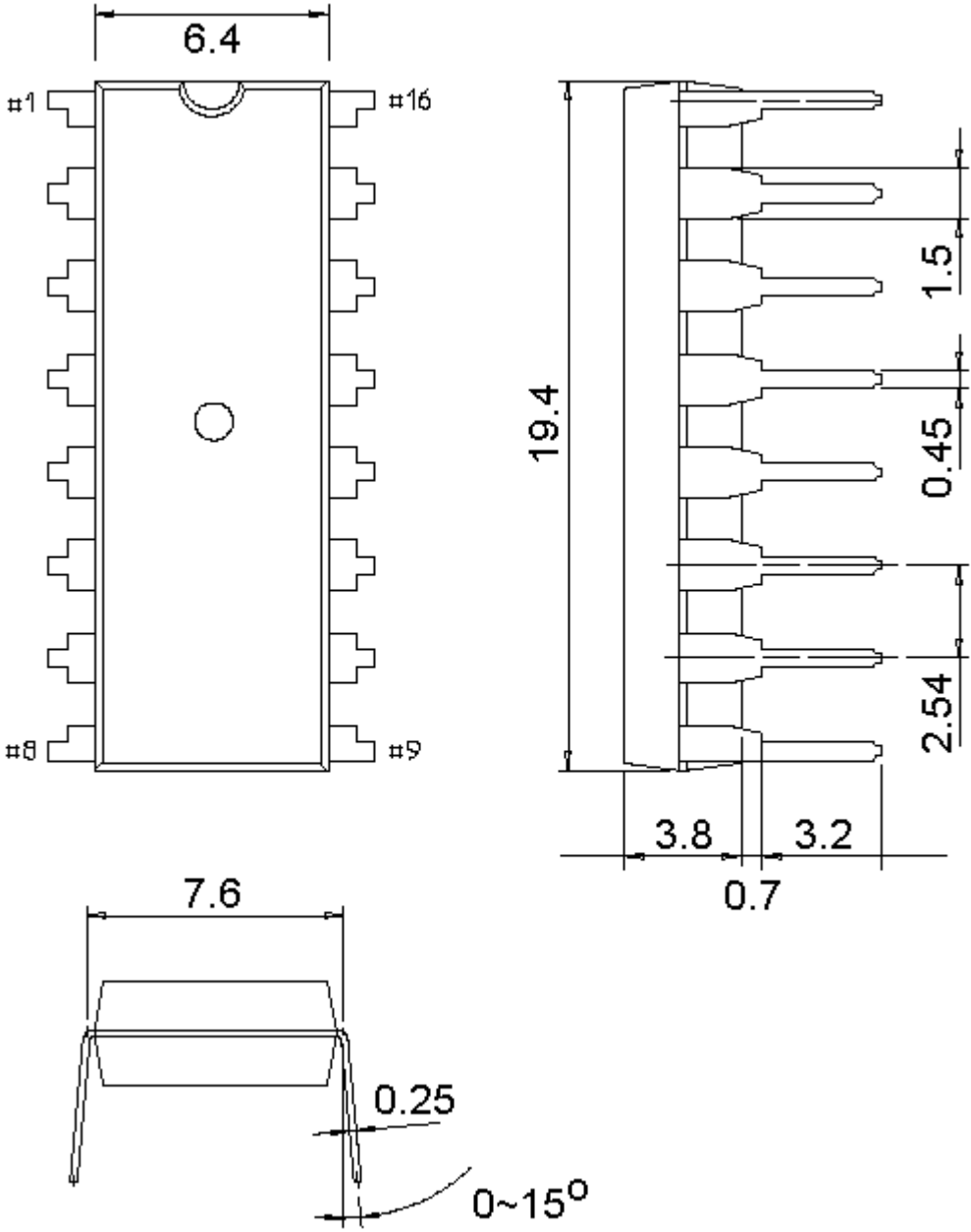

DIP18

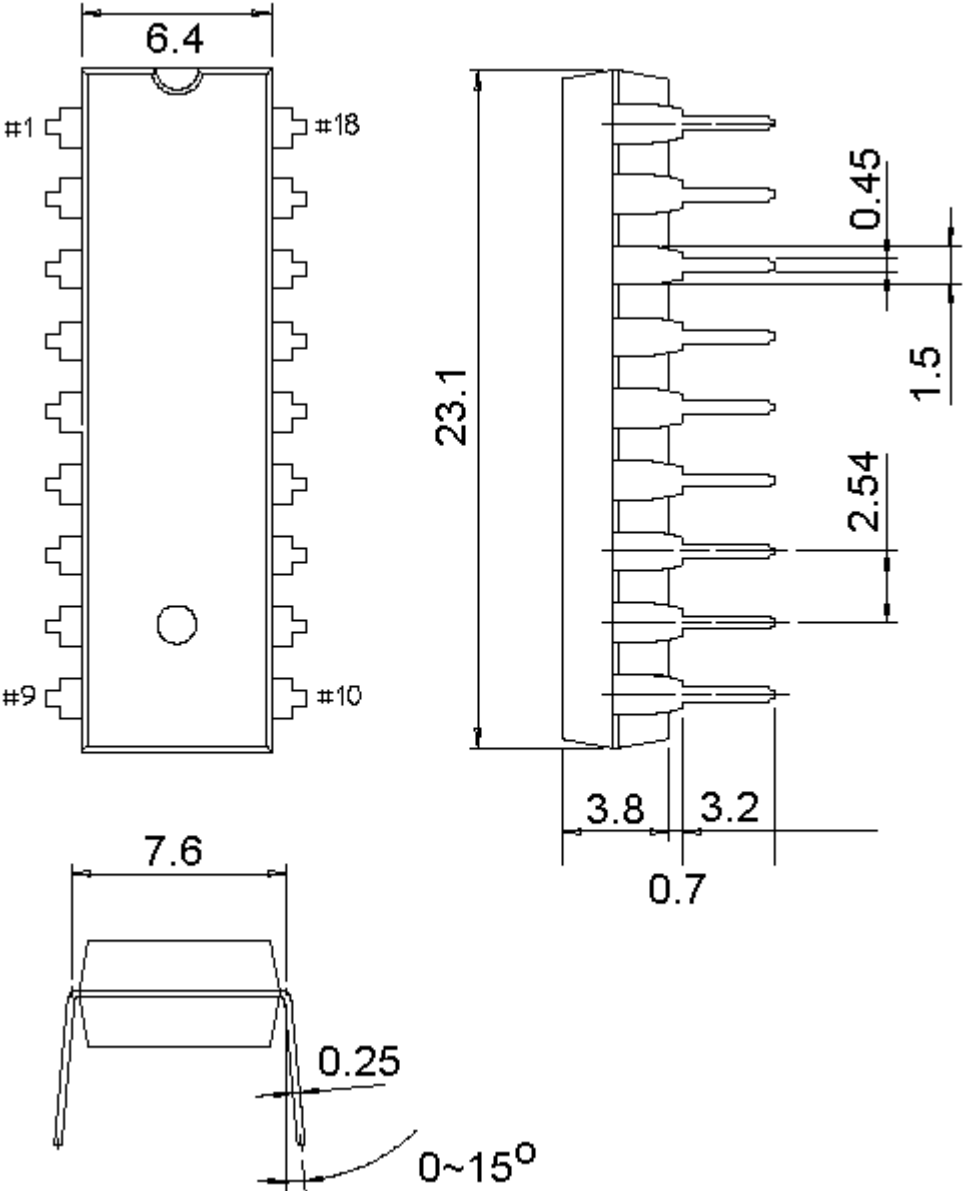

DIP20

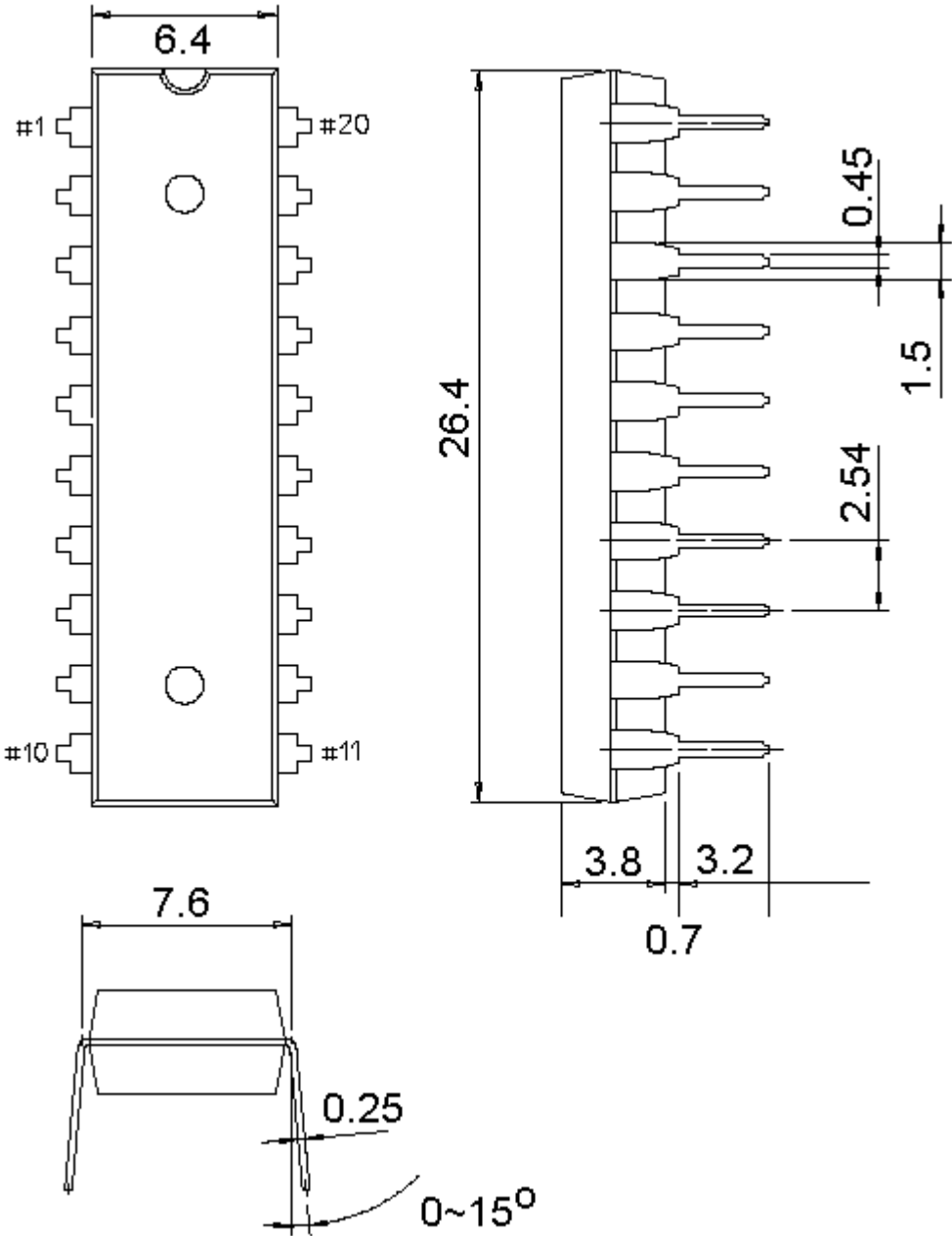

DIP24S (SKDIP24、DIP24-300mil)

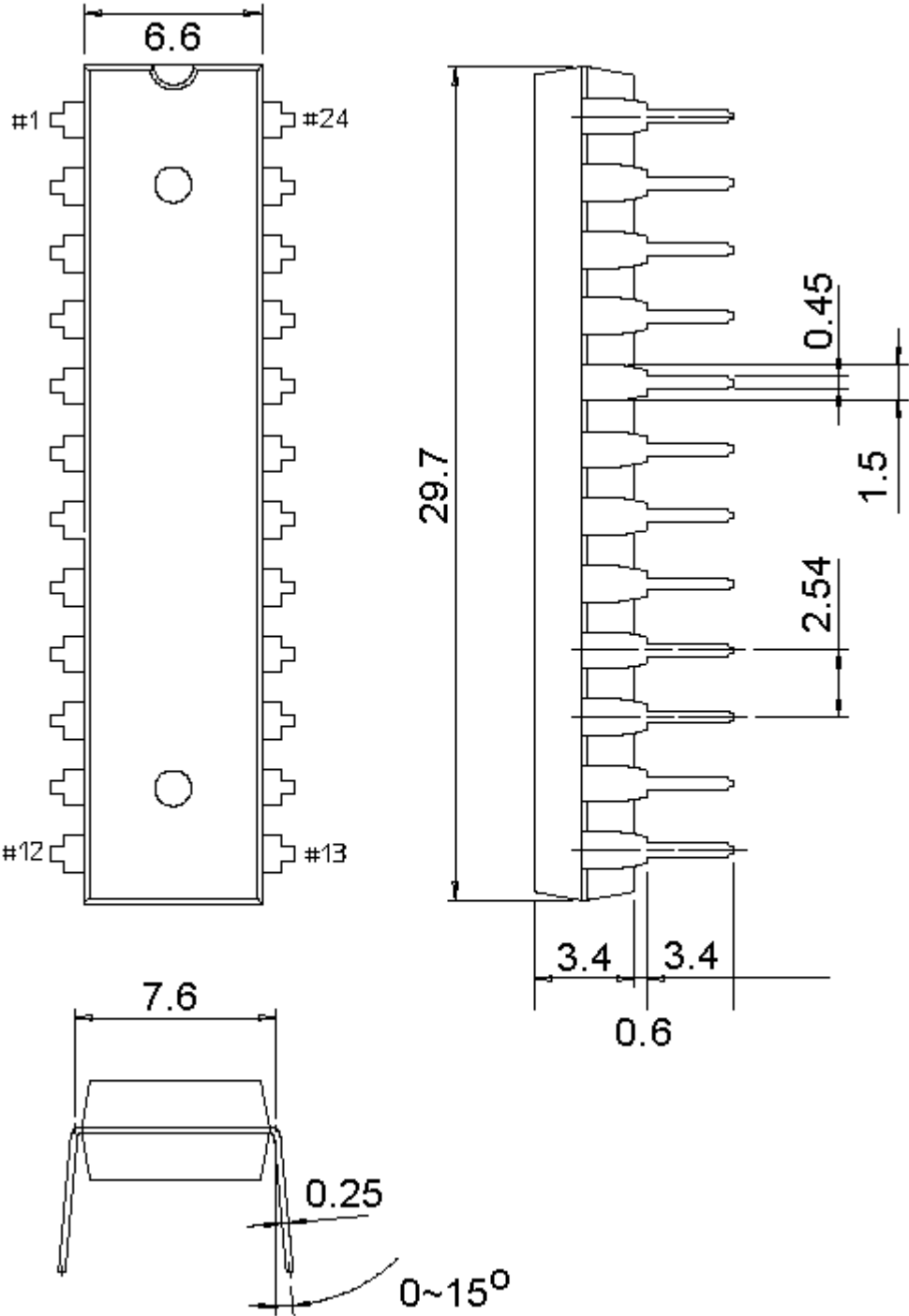



DIP28S (SKDIP28、DIP28-300mil)

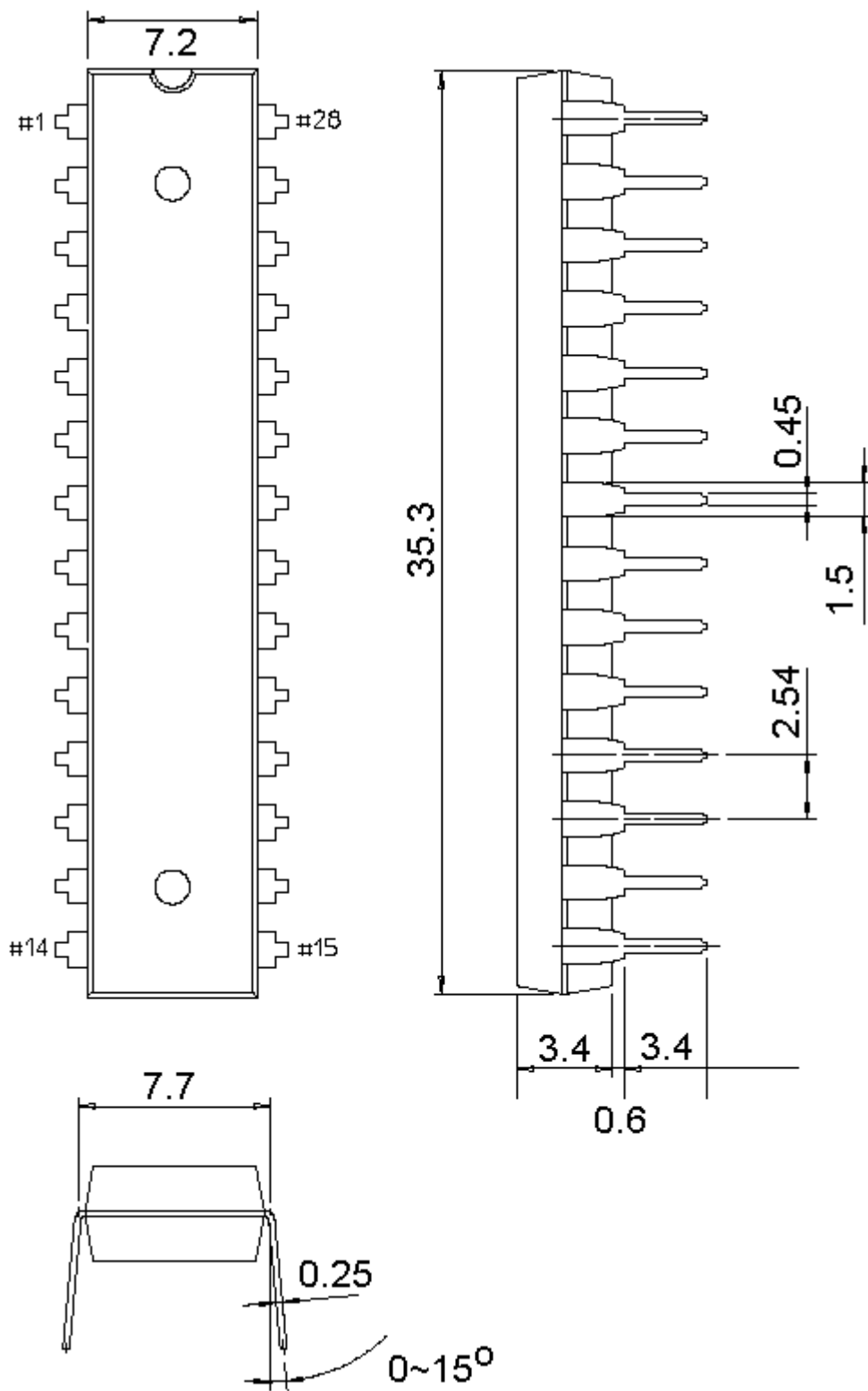

DIP28 (DIP28W、DIP28-600mil)

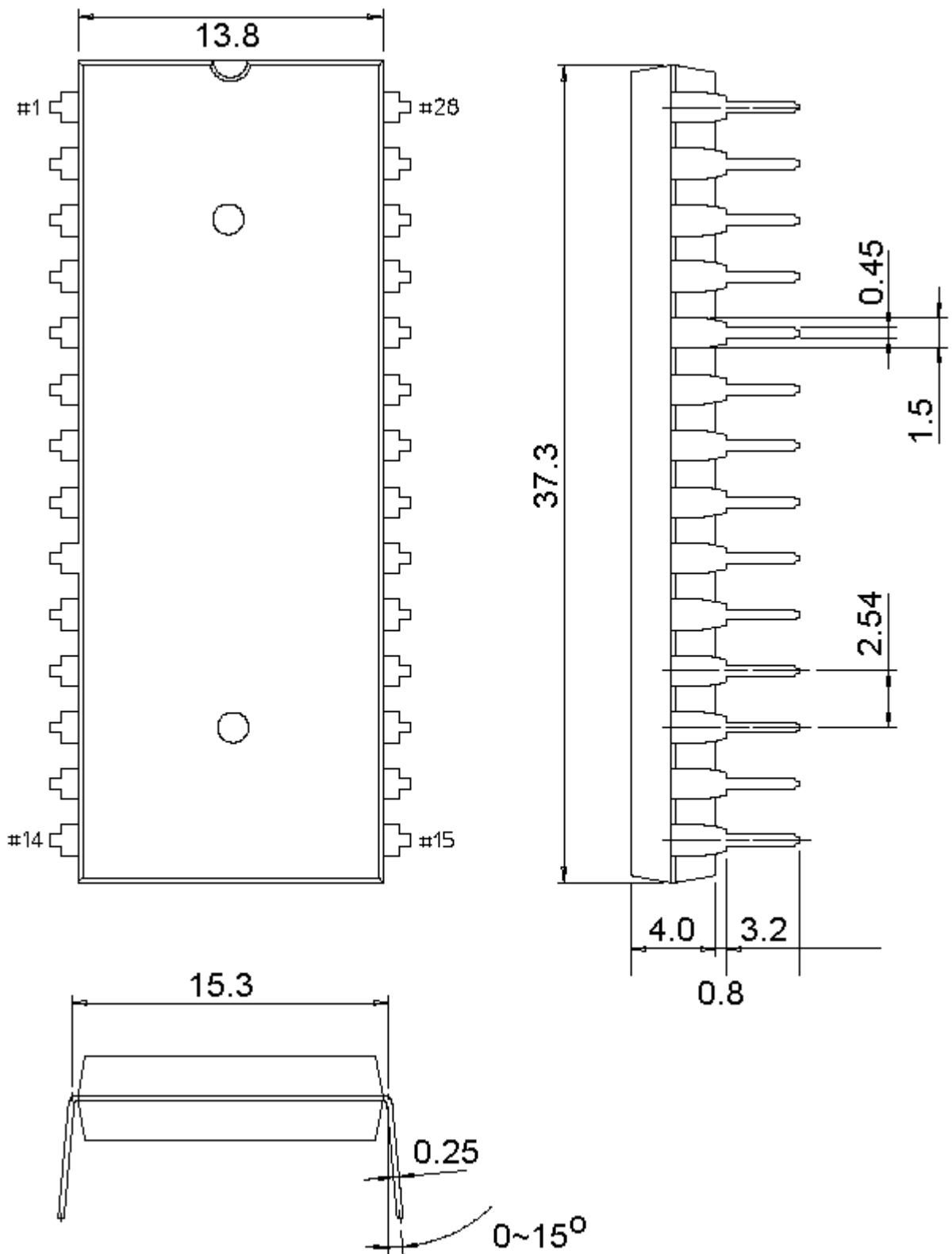

SDIP28 (SDIP28-400mil)

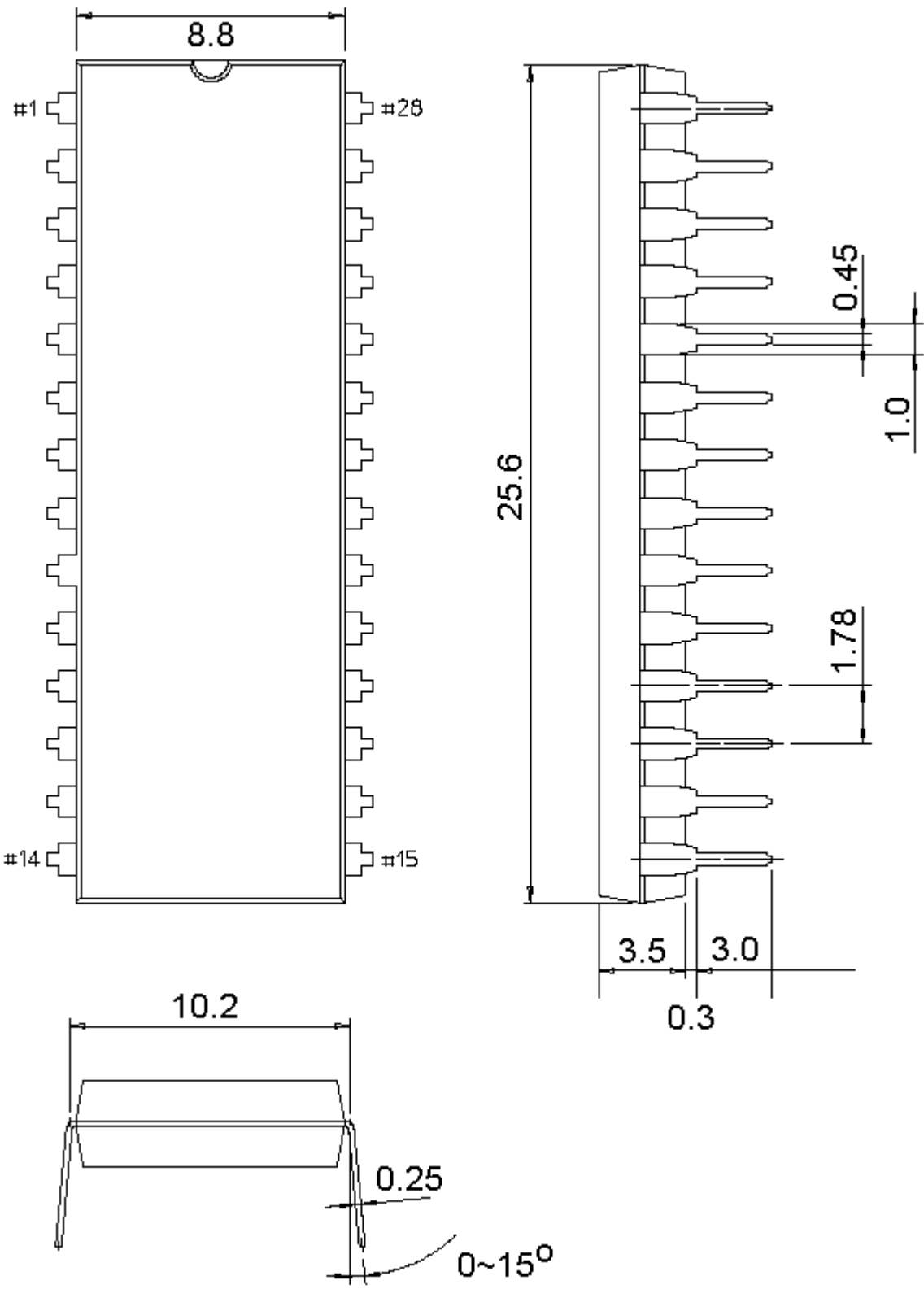

SDIP32 (SDIP32-400mil)

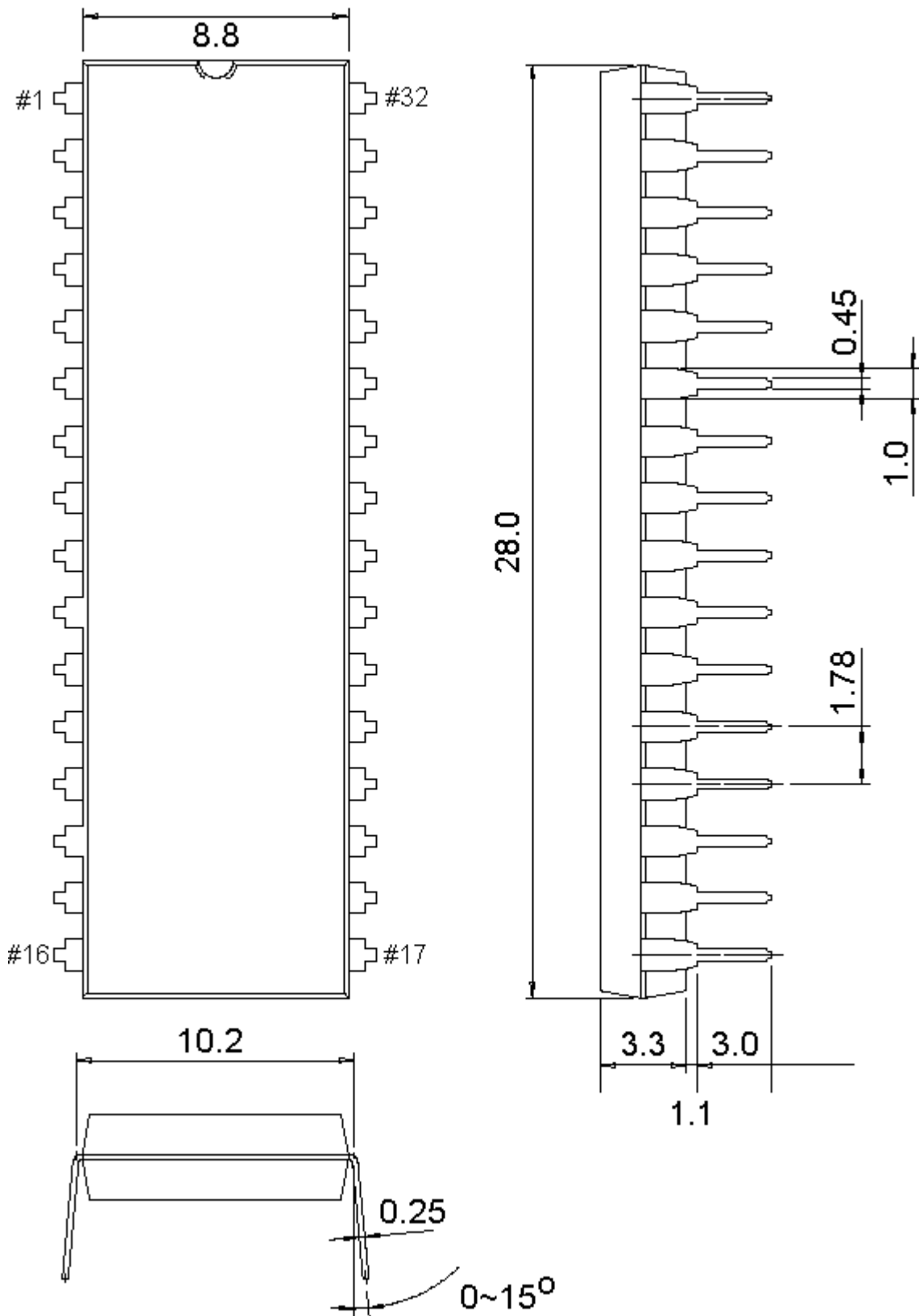

### SOP 类 (SOIC)

SOP8、eSOP8

eSOP8 Exposed Pad: 2.1\*3.3、2.1\*2.1

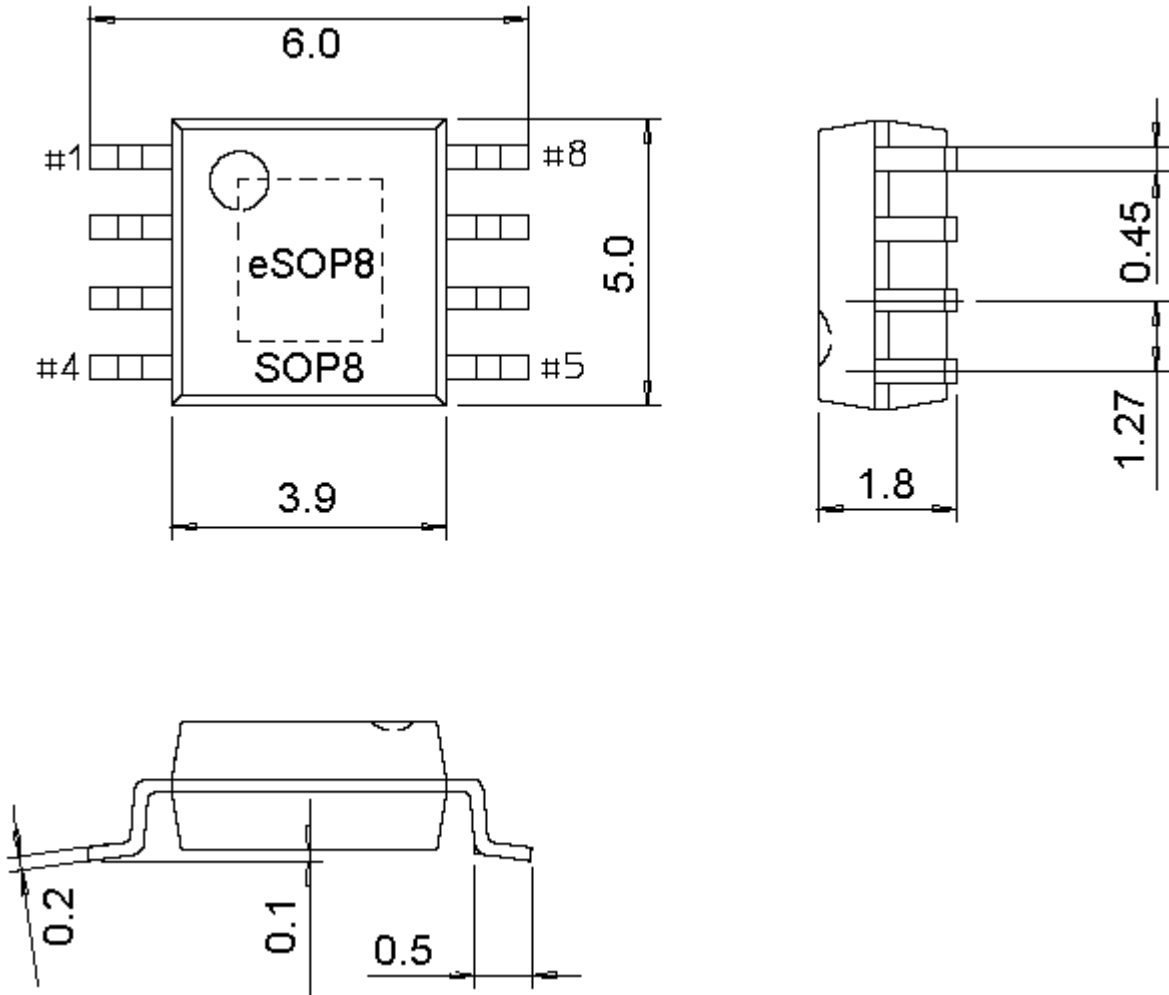

SOP14

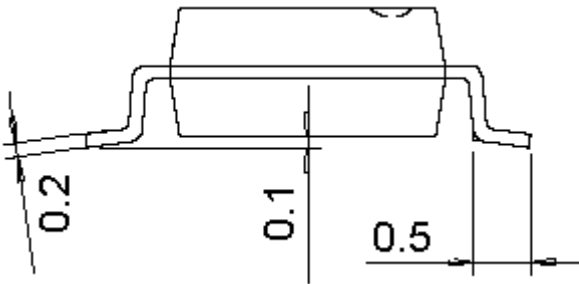
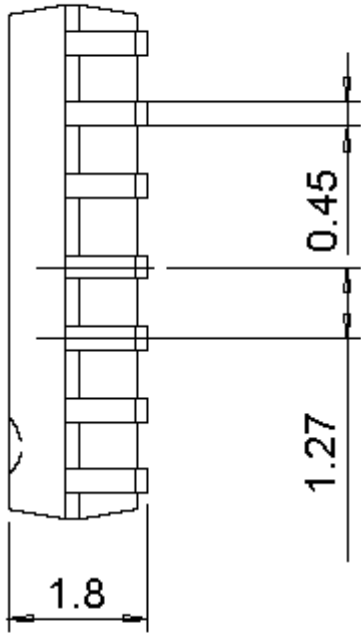
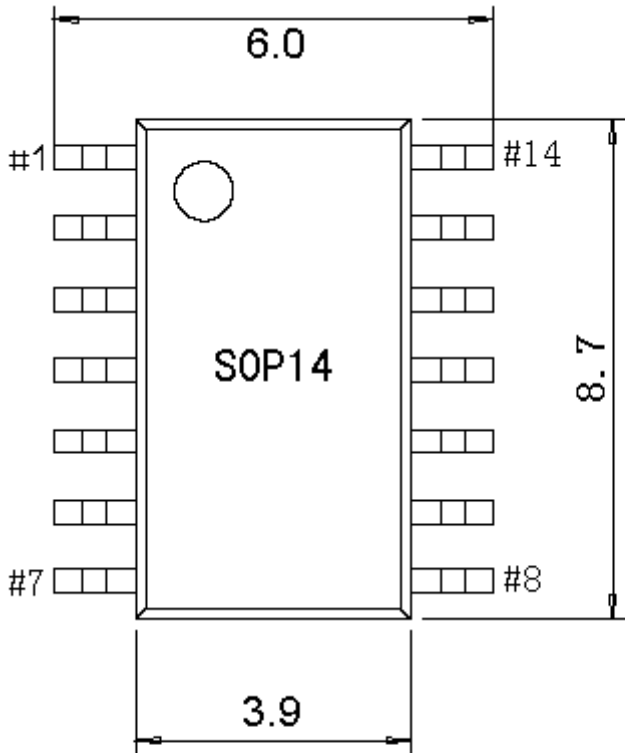

SOP16 (SOP16-150mil)

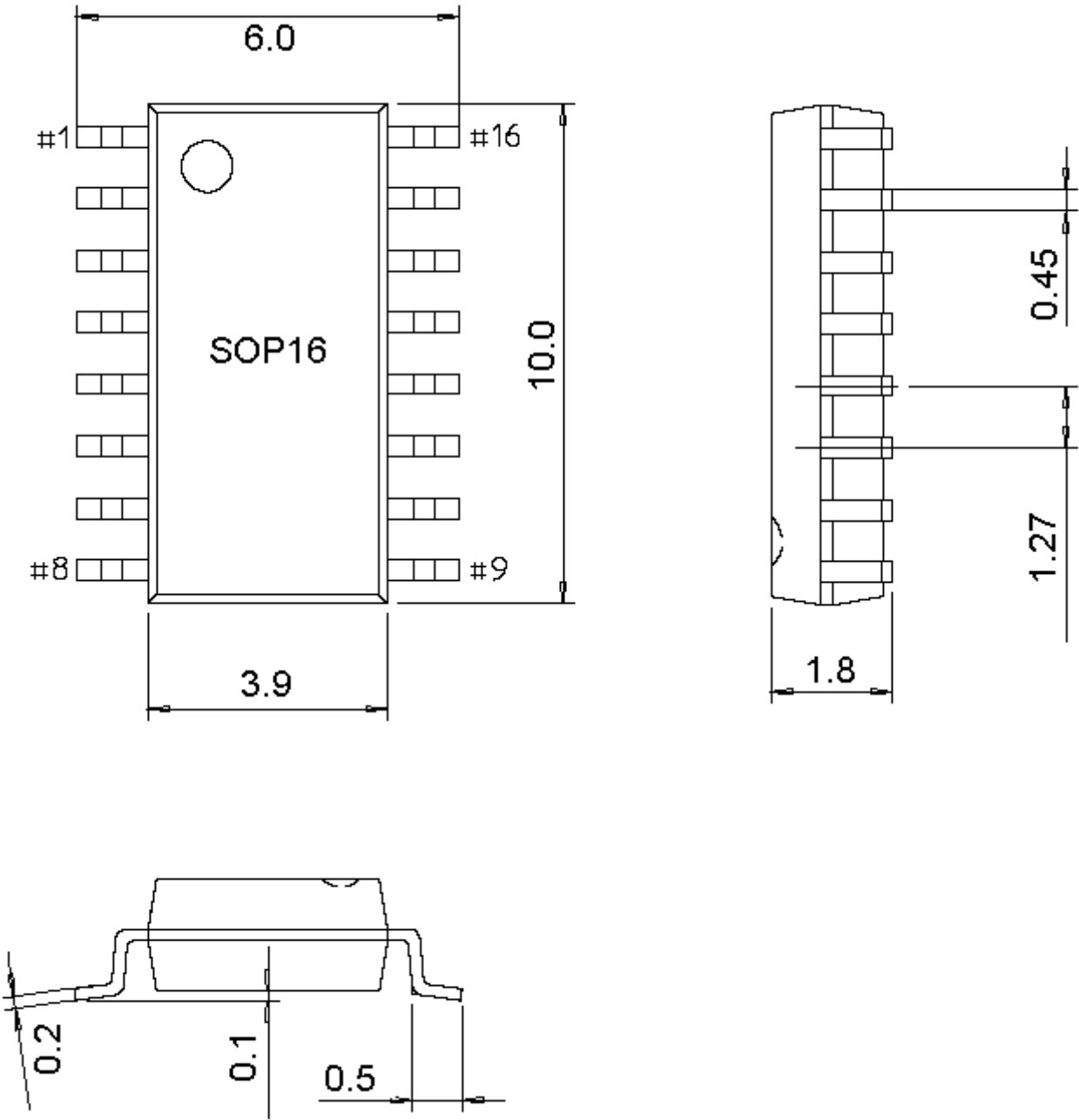

SOP18

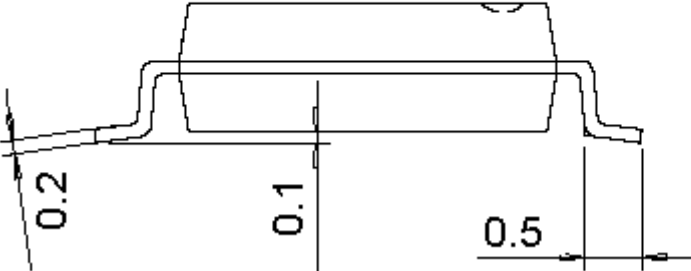
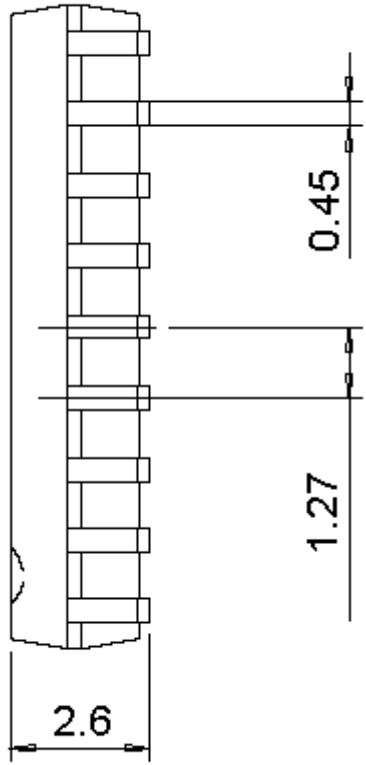
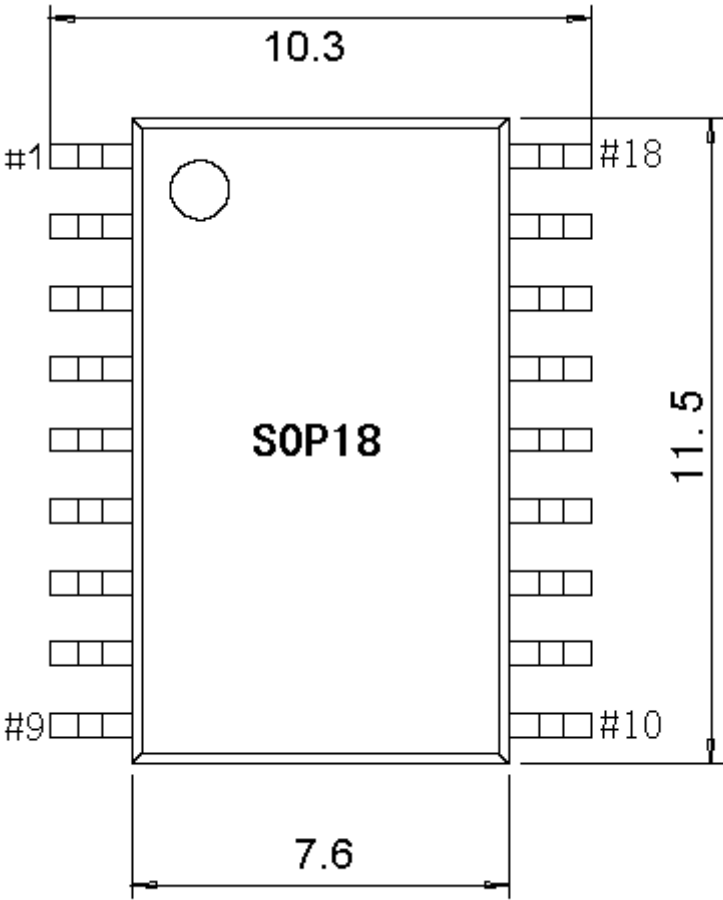



SOP20

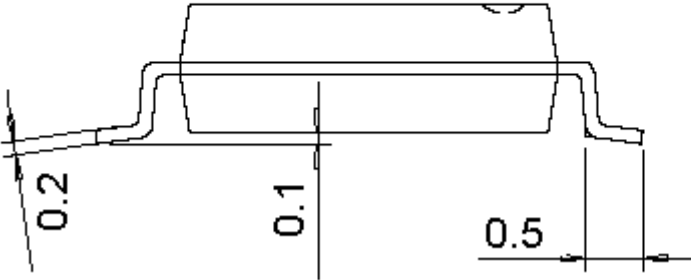
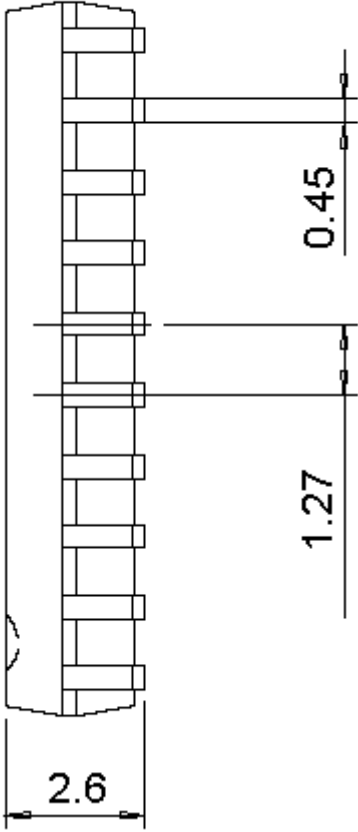
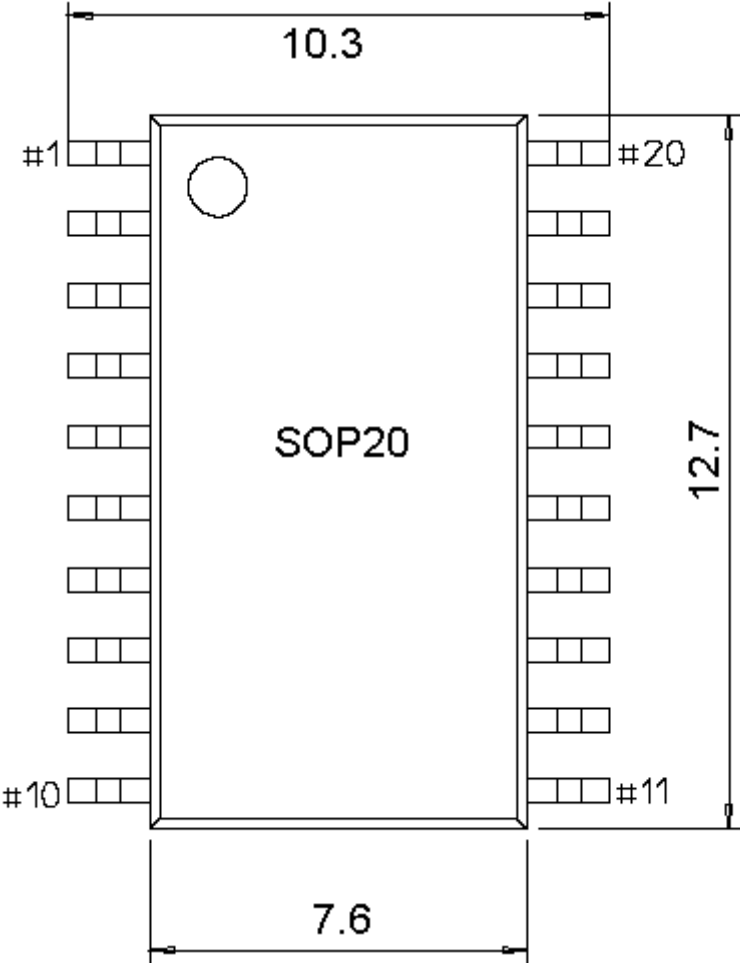

SOP24

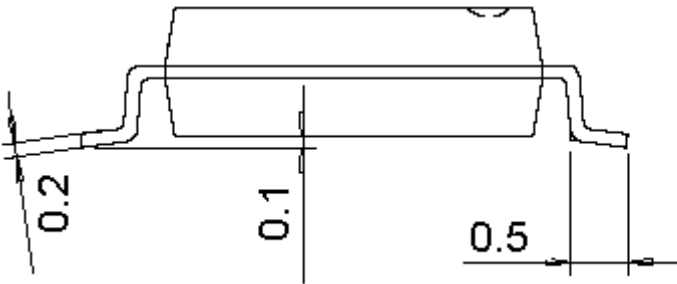
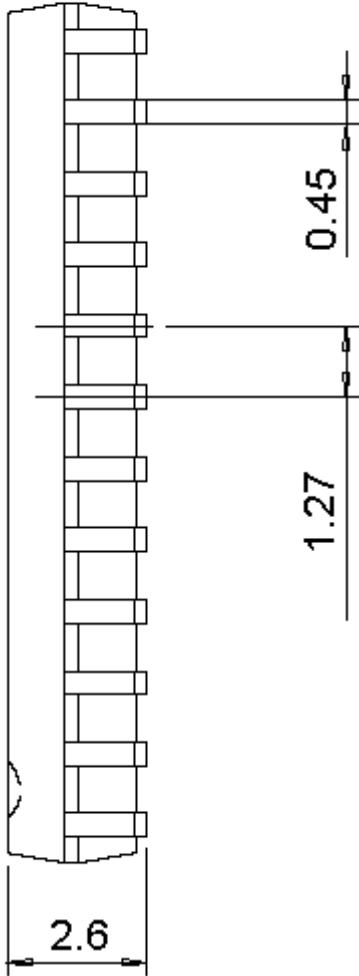
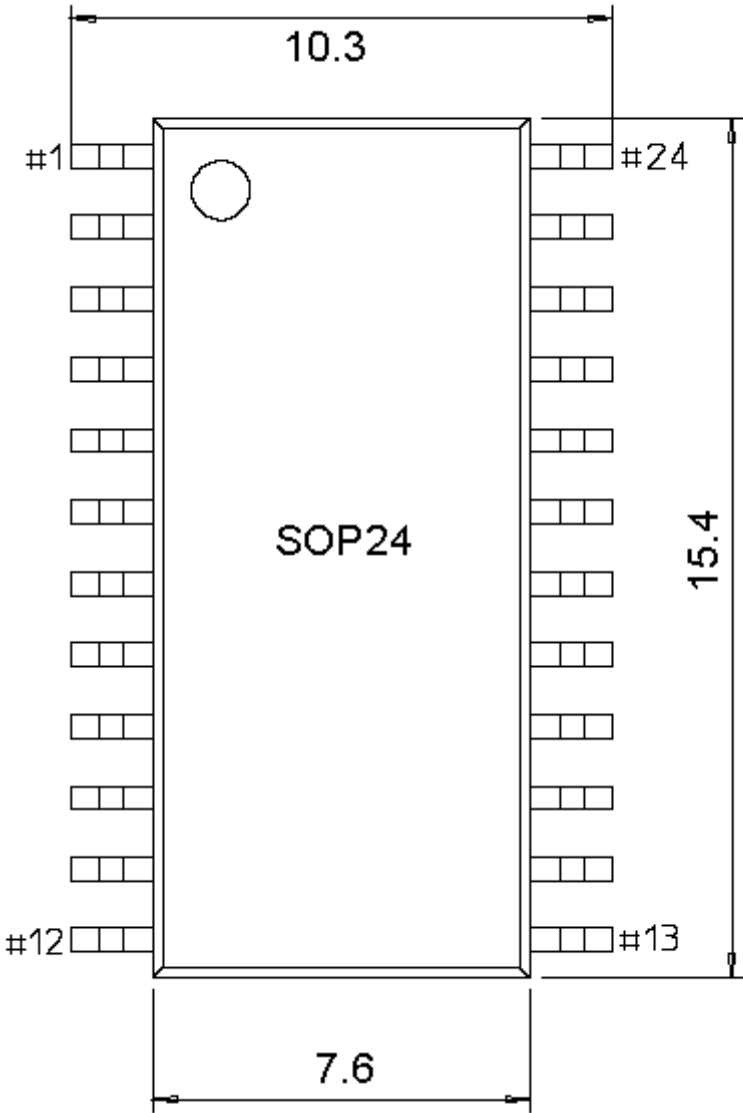

SOP28

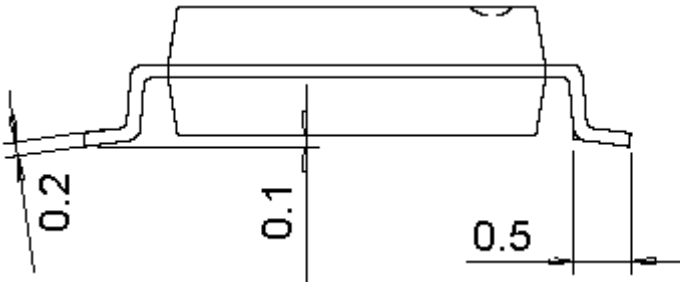
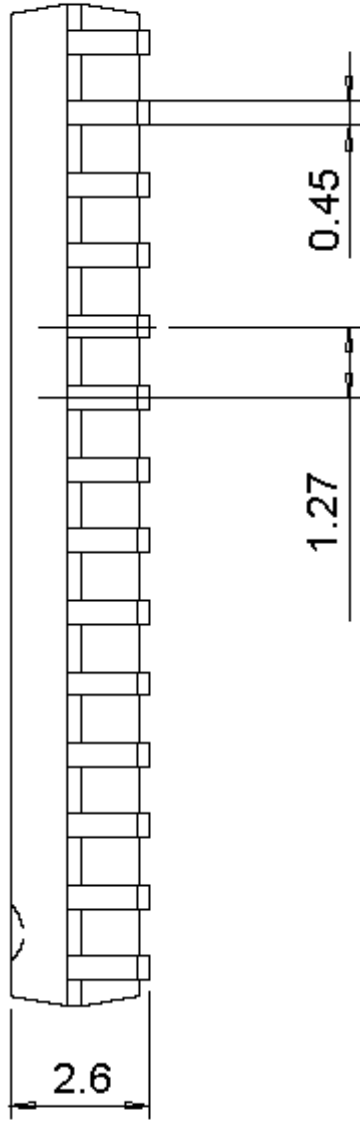
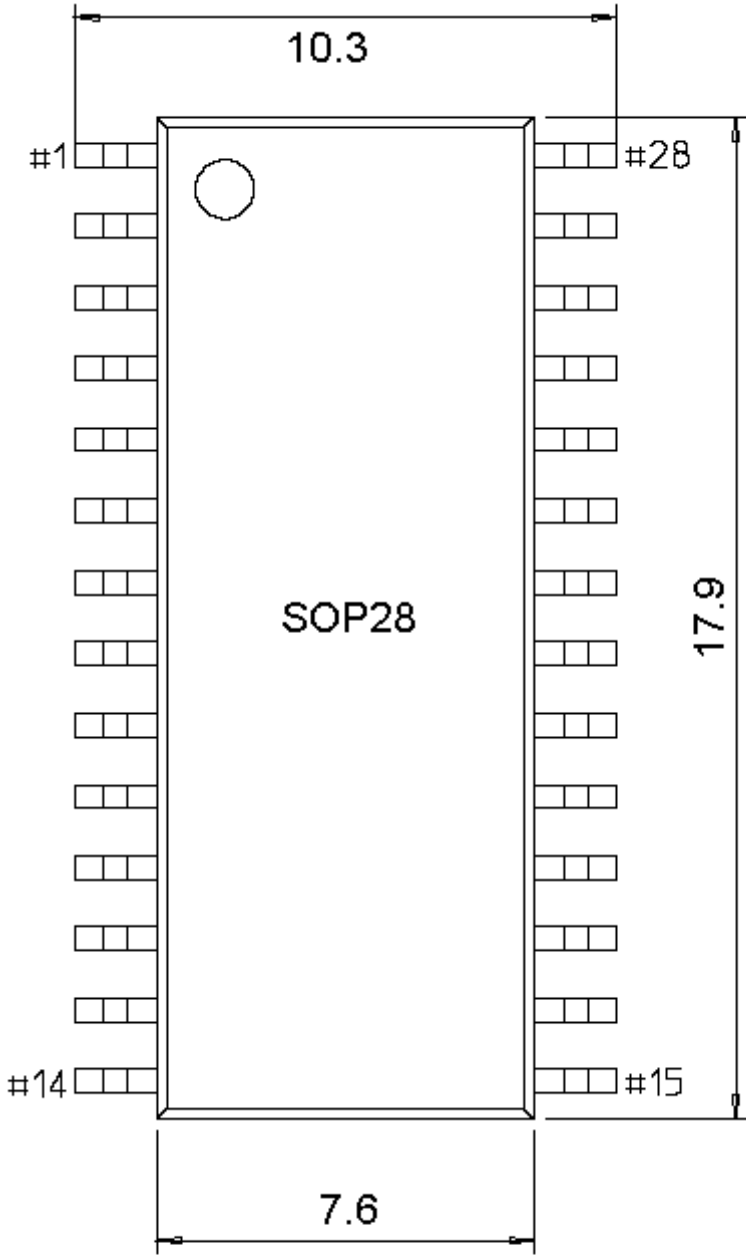

SOP30

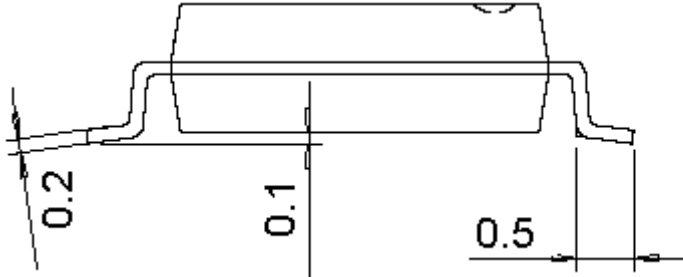
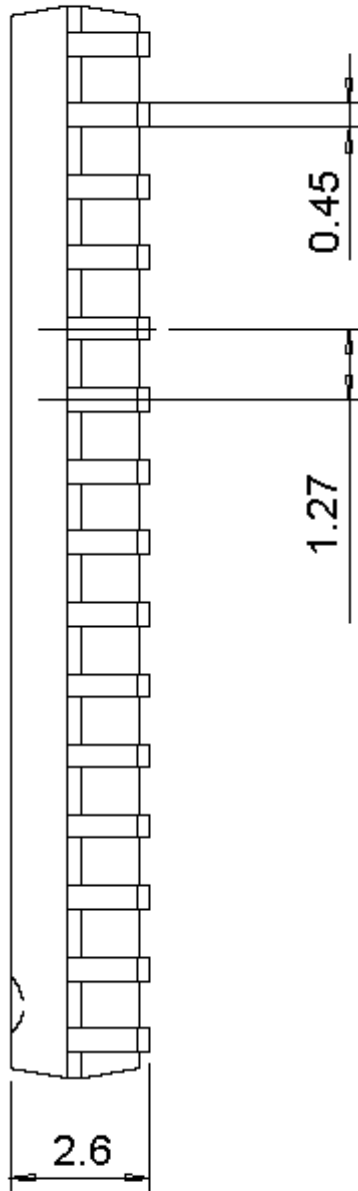
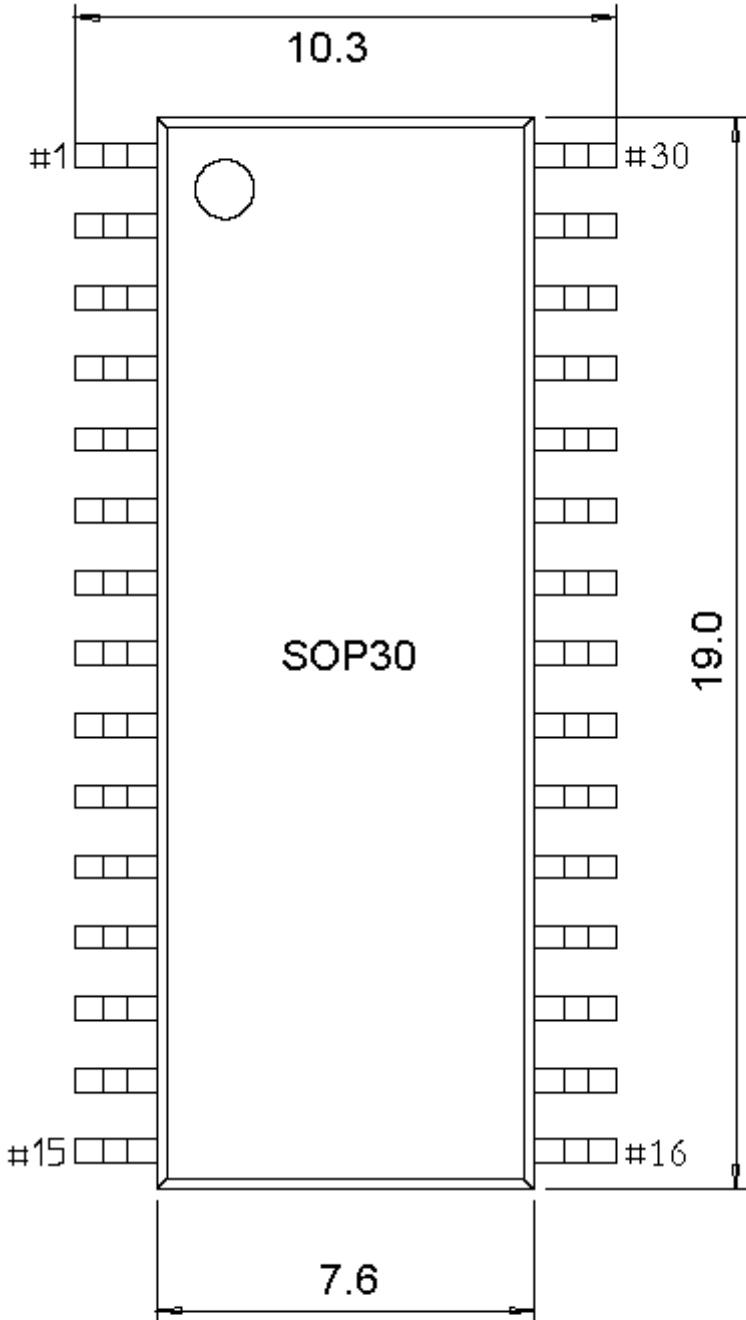

SSOP 类

SSOP10 (SSOP10-150mil-1.00)、eSSOP10

eSSOP10 Exposed Pad: 2.1\*3.3

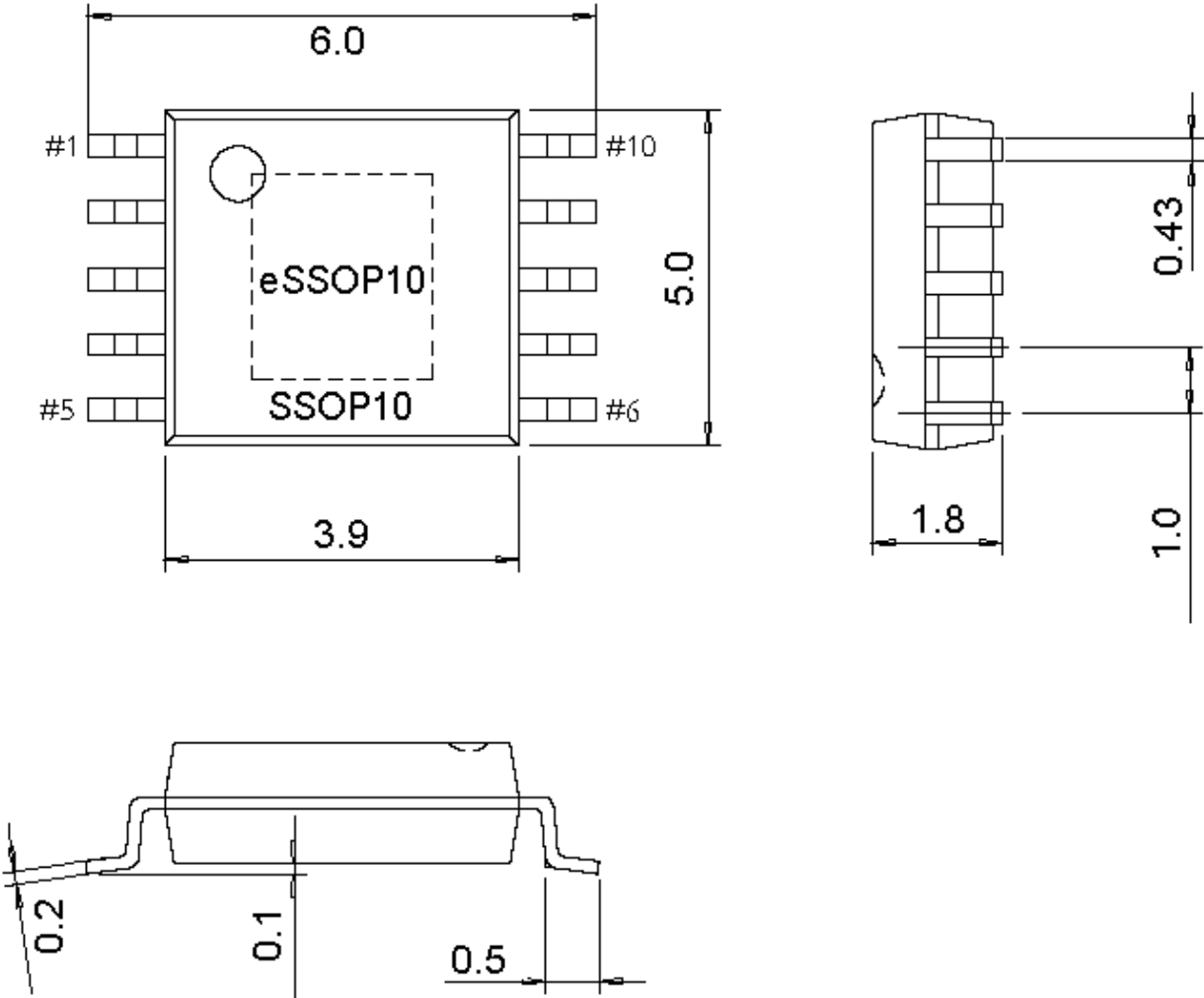

SSOP16 (SSOP16-209mil-0.65)

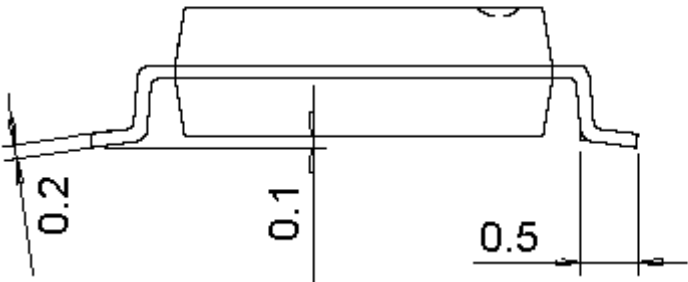
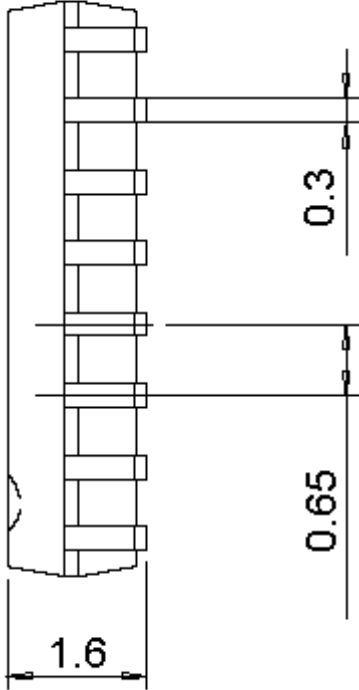
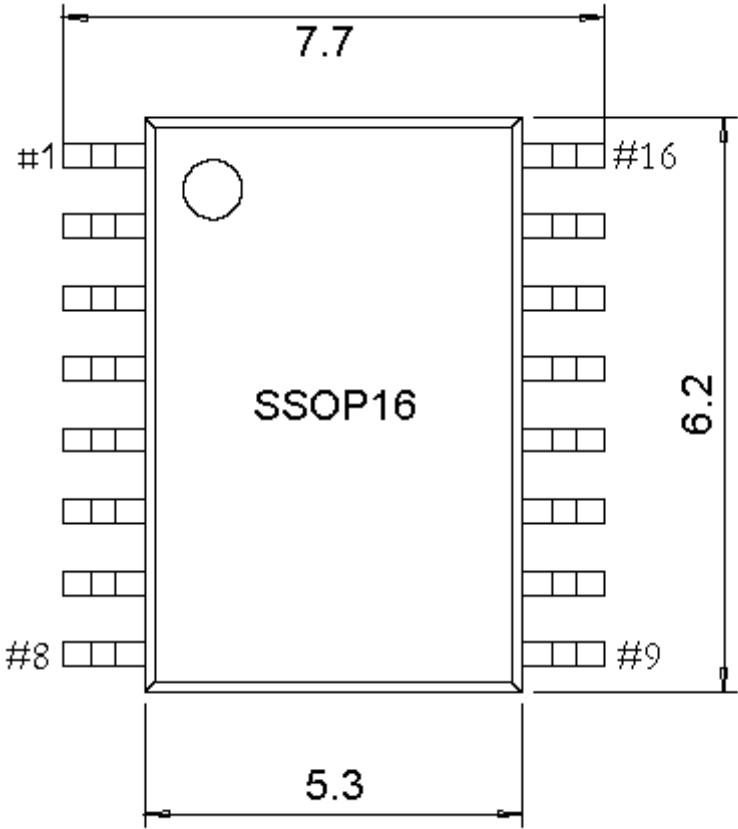

SSOP20 (SSOP20-209mil-0.65)

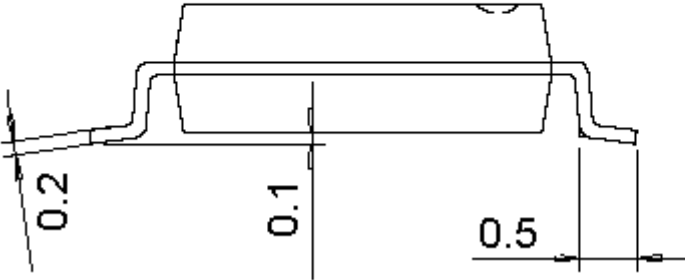
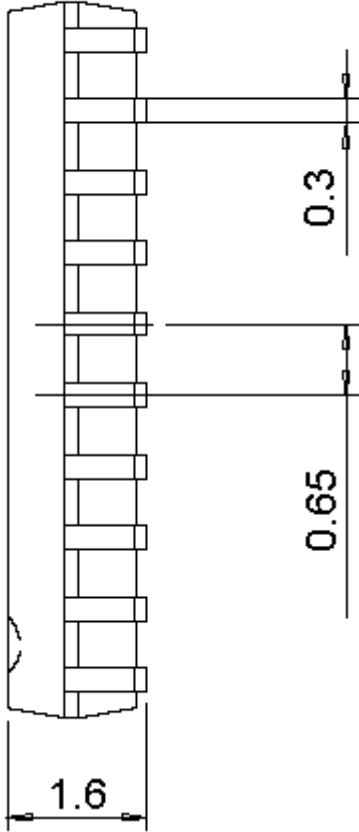
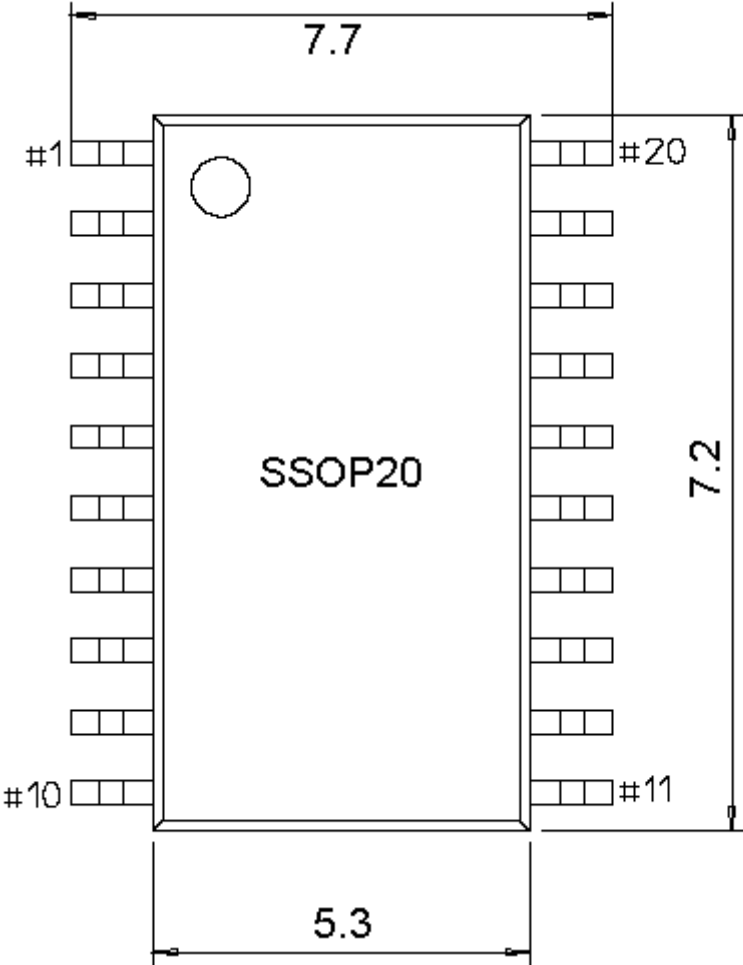

SSOP24 (SSOP24-209mil-0.65)

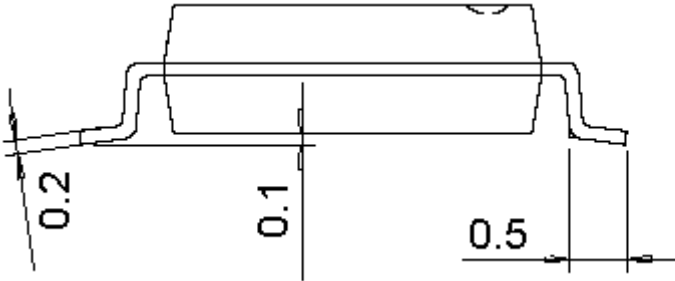
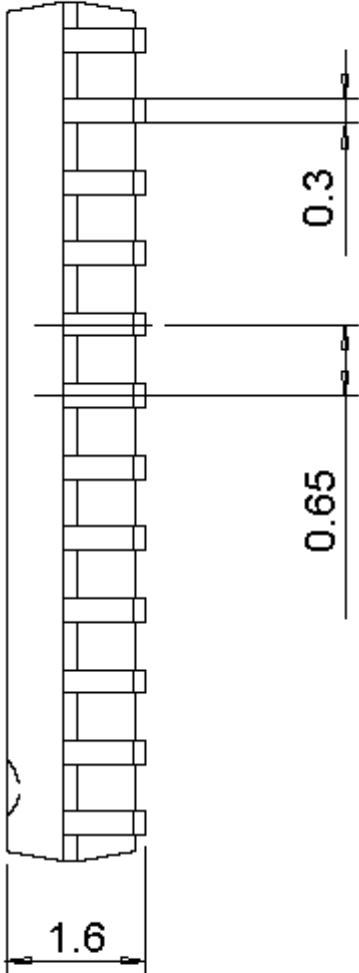
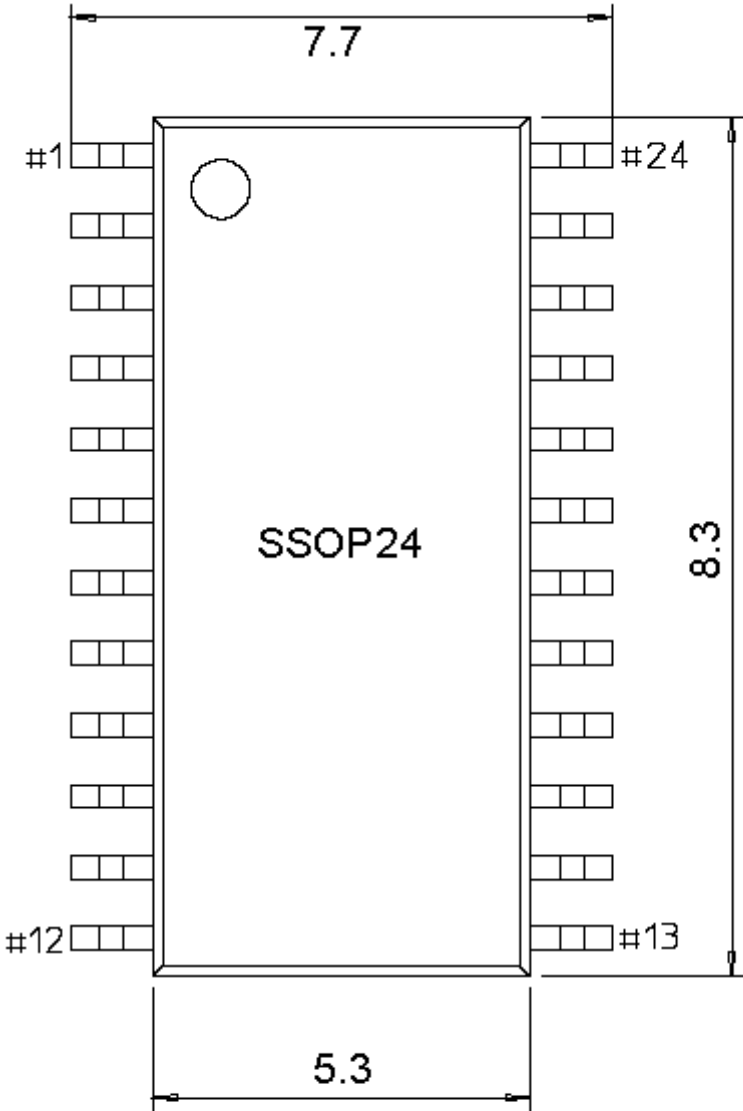



SSOP28 (SSOP28-209mil-0.65)

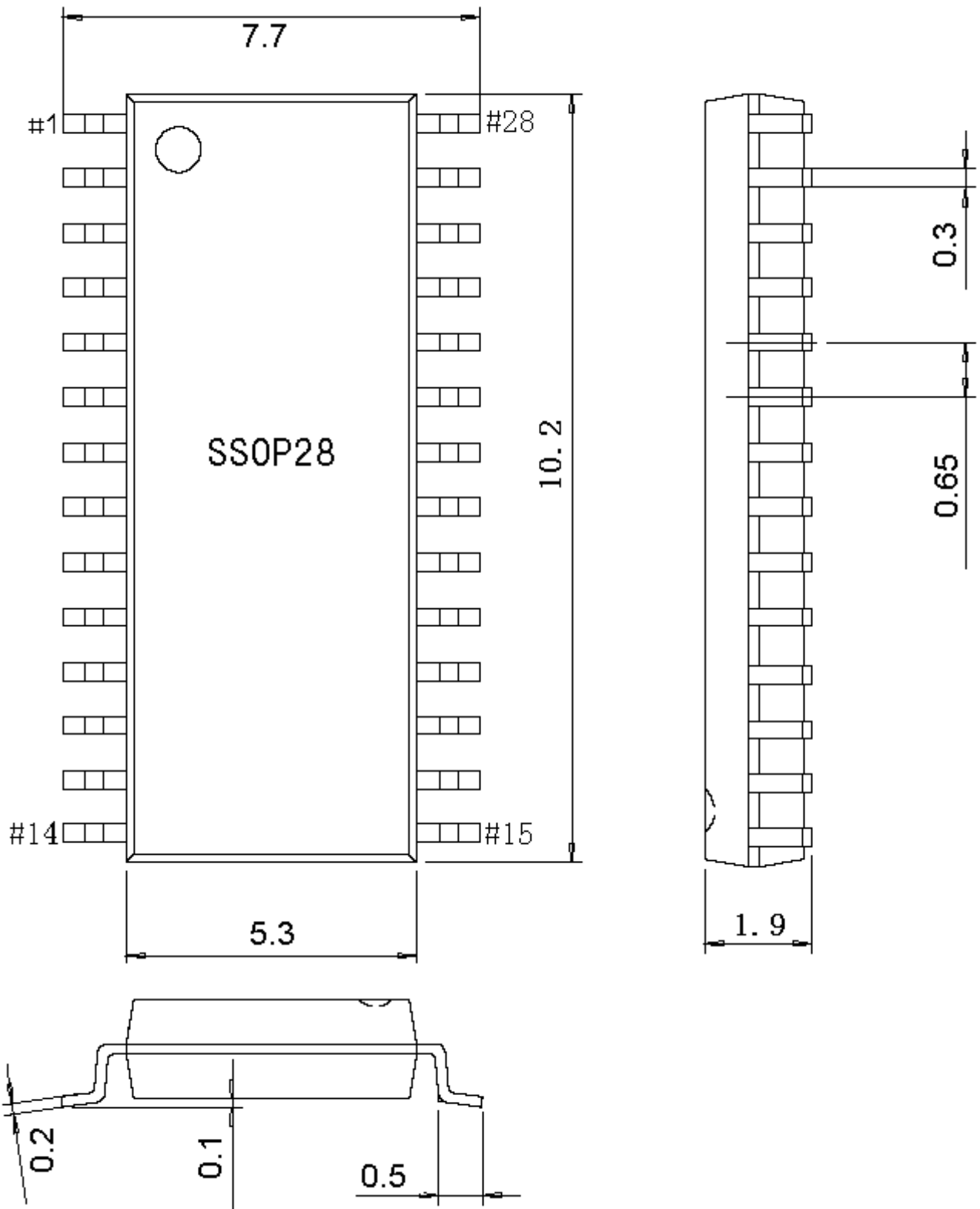

MSOP 类

MSOP10

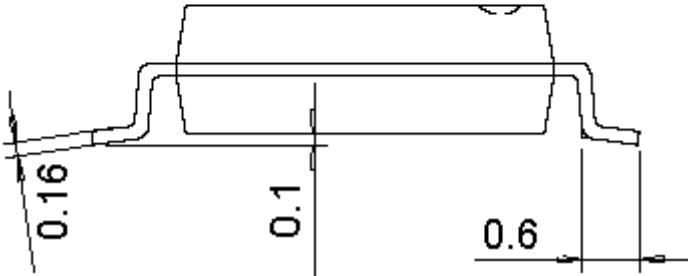
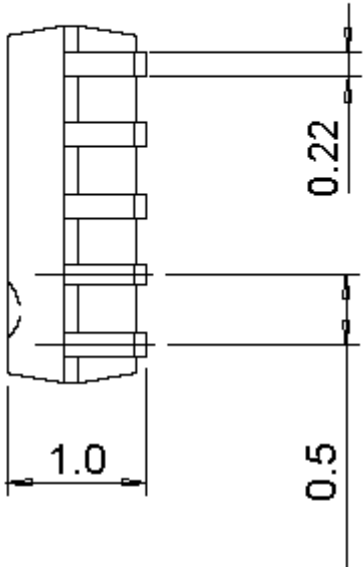
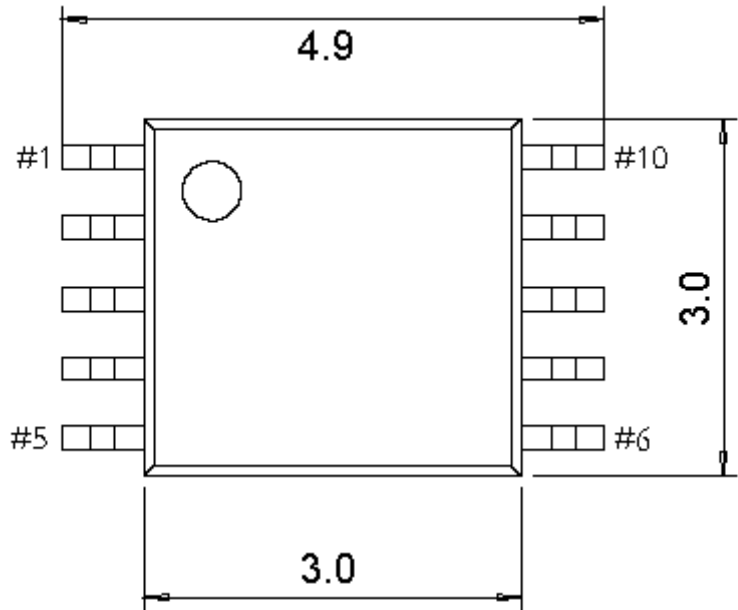

TSSOP 类 (4.4mm, 173mil)

TSSOP8

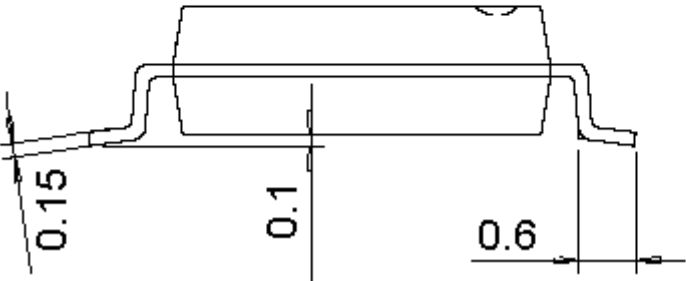
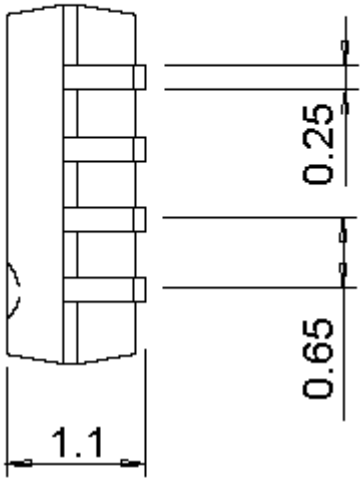
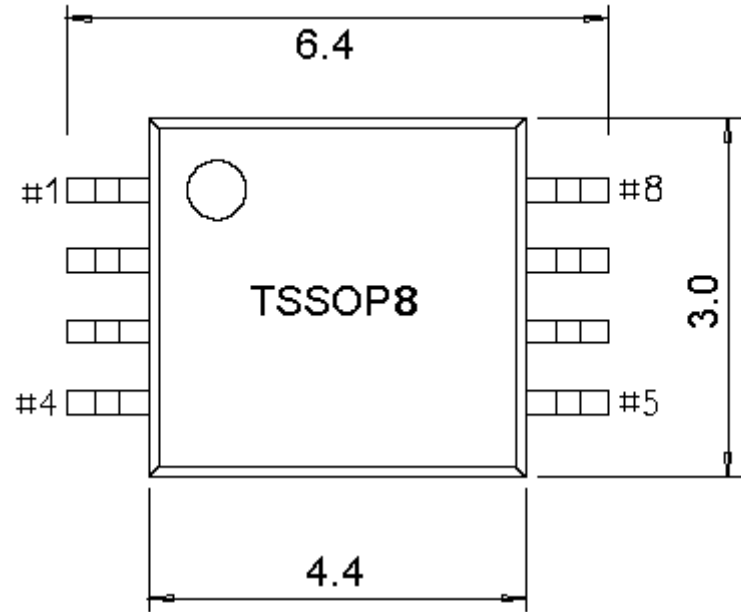

TSSOP14、eTSSOP14

eTSSOP14 Exposed Pad: 3.0\*3.0

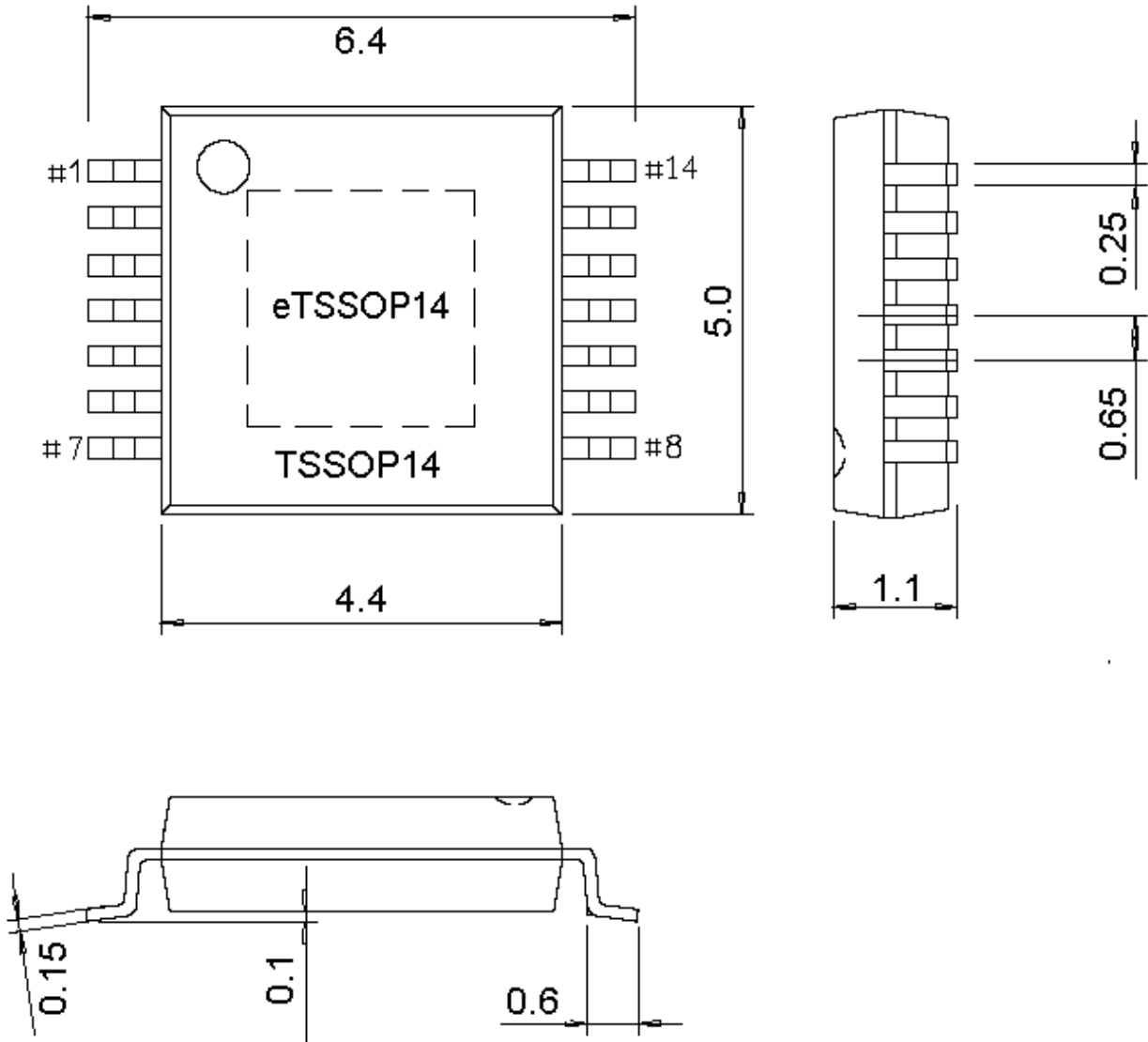

TSSOP16、eTSSOP16

eTSSOP16 Exposed Pad: 2.8\*3.0

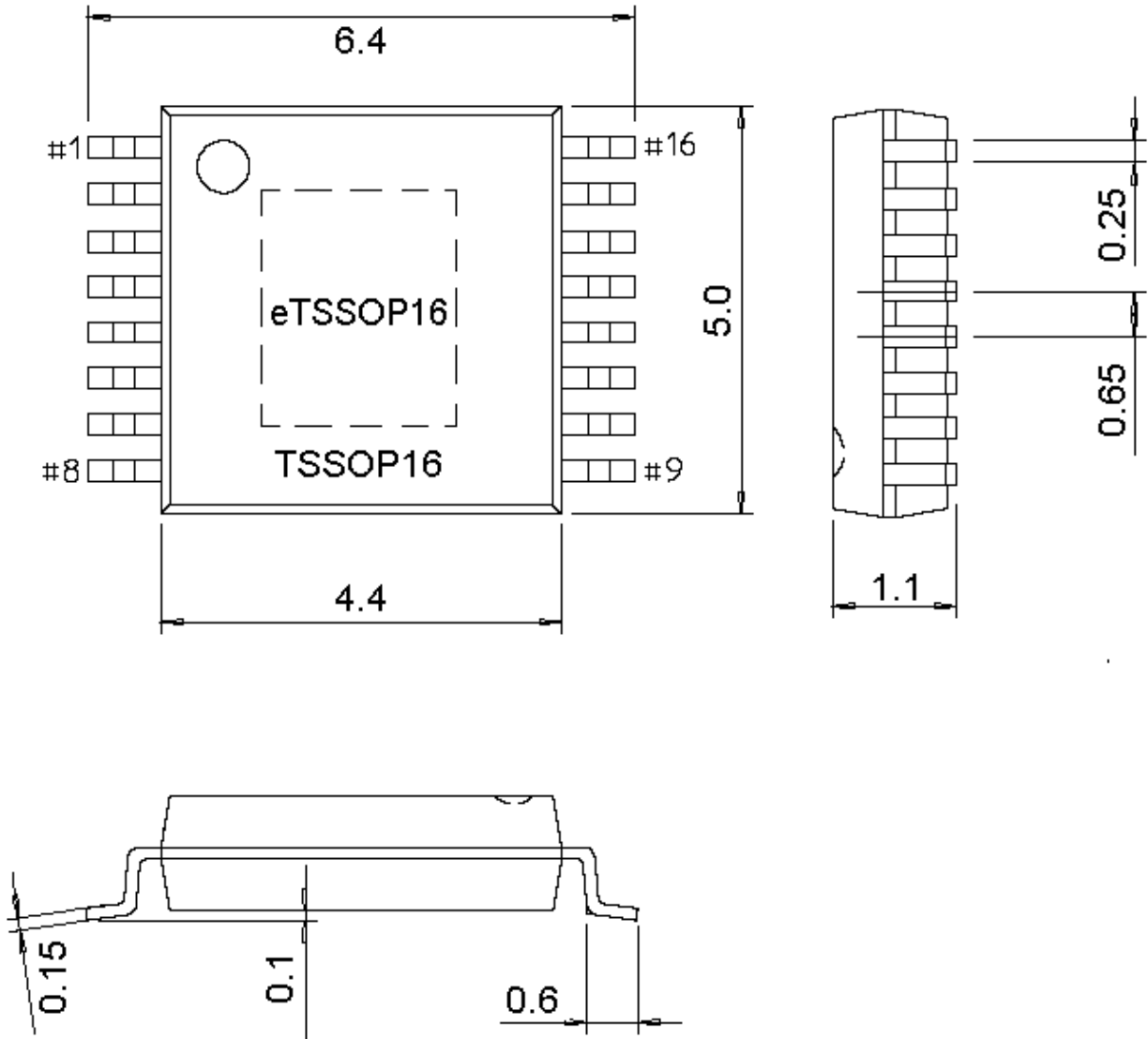

TSSOP20、eTSSOP20

eTSSOP20 Exposed Pad: 3.0\*4.2

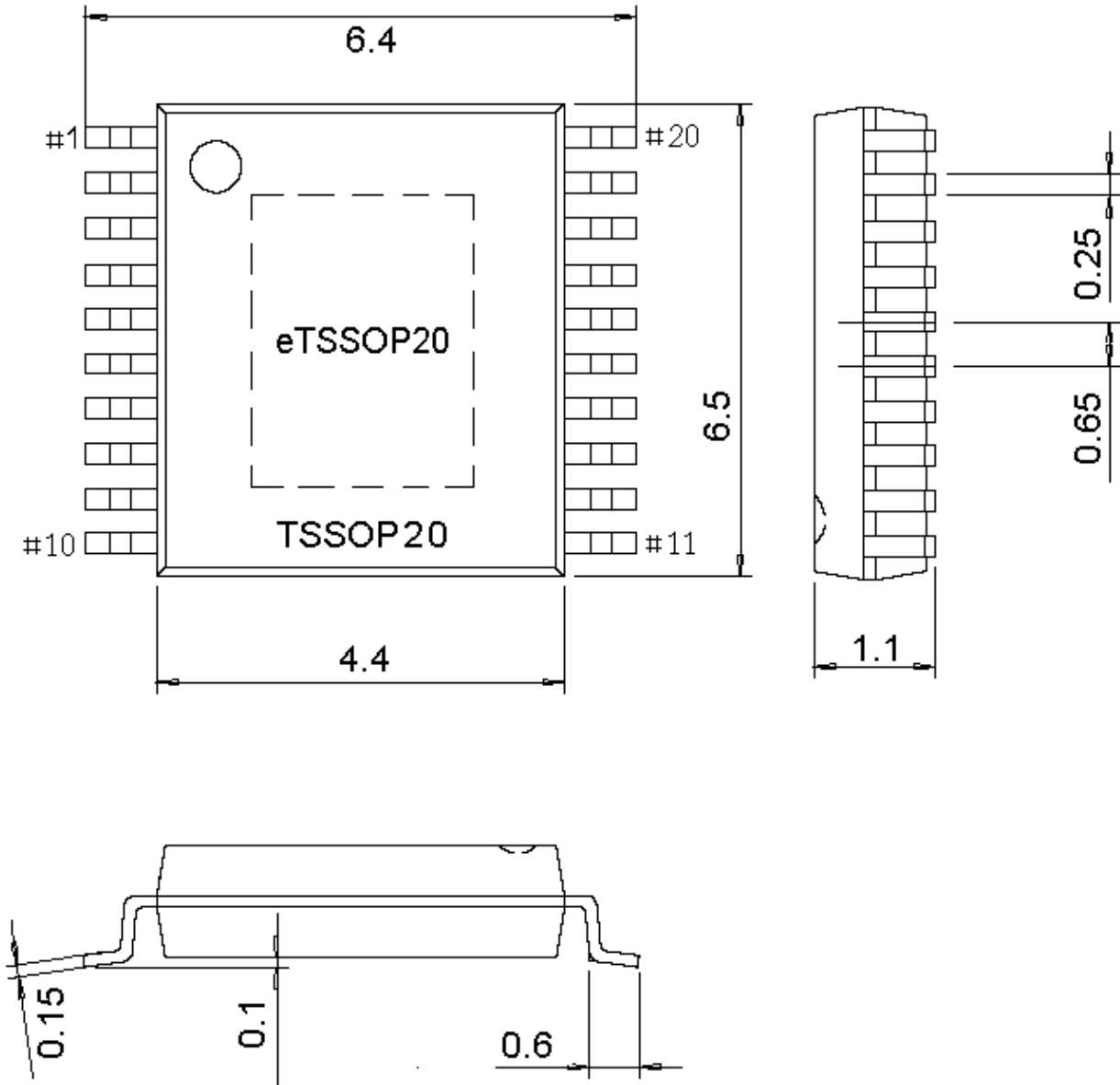

TSSOP24

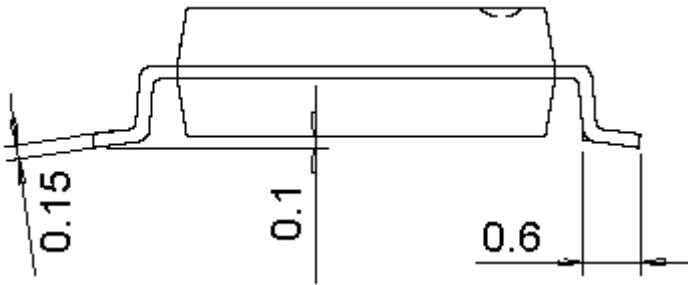
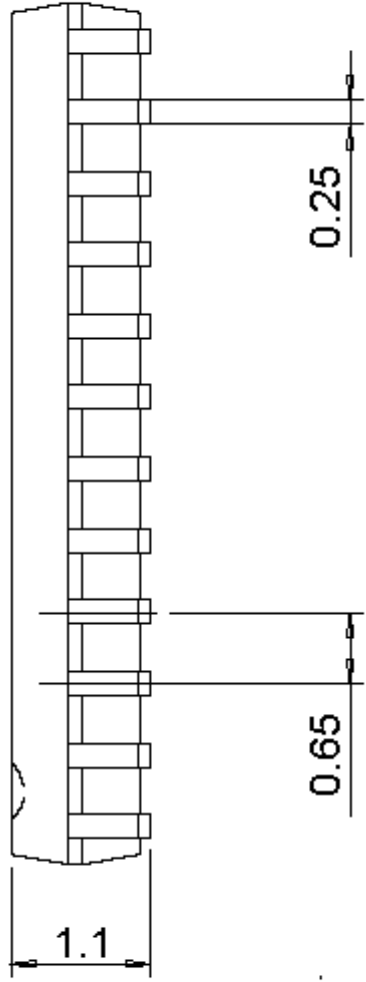
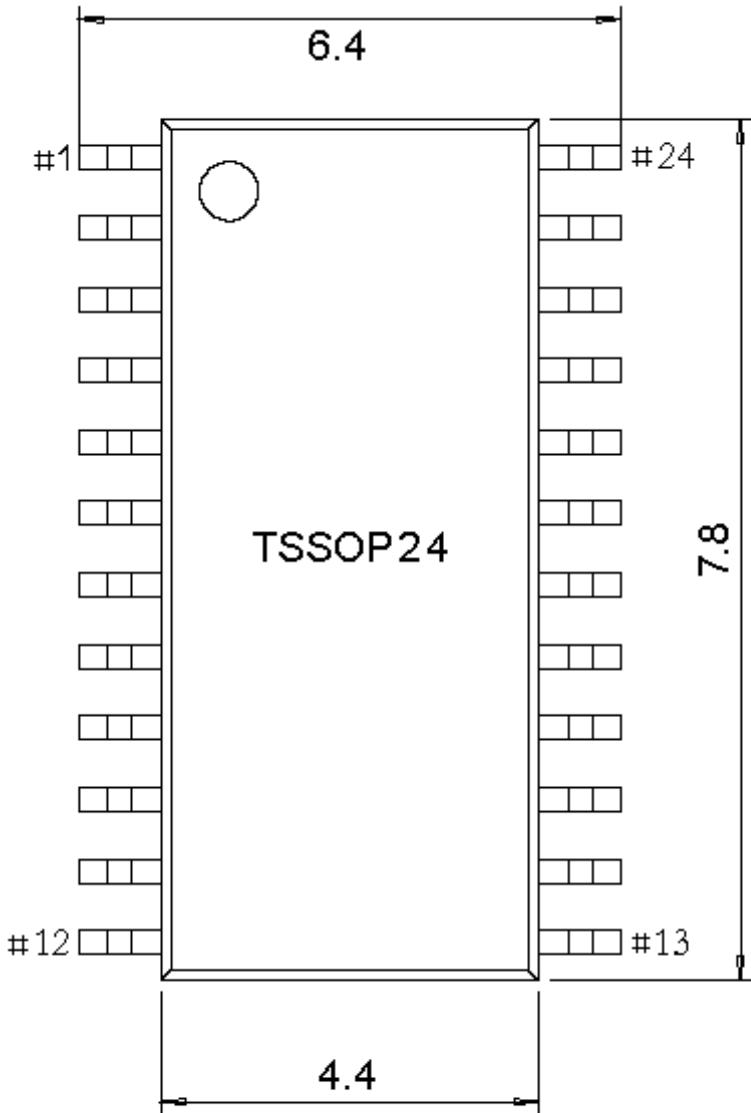

TSSOP28

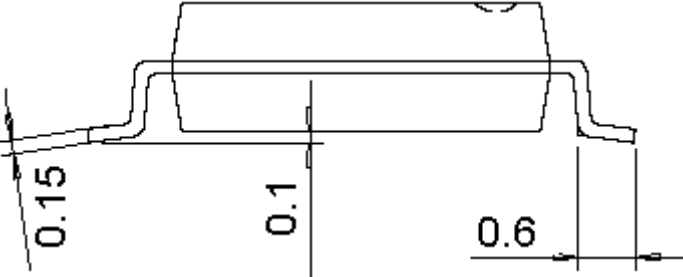
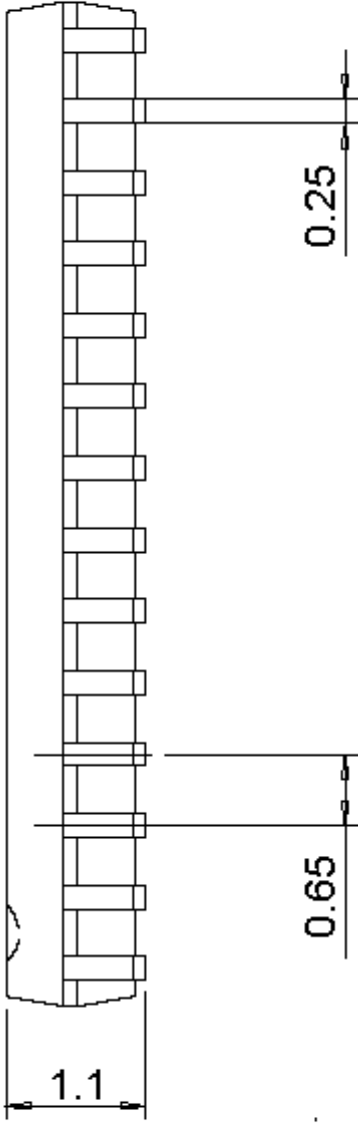
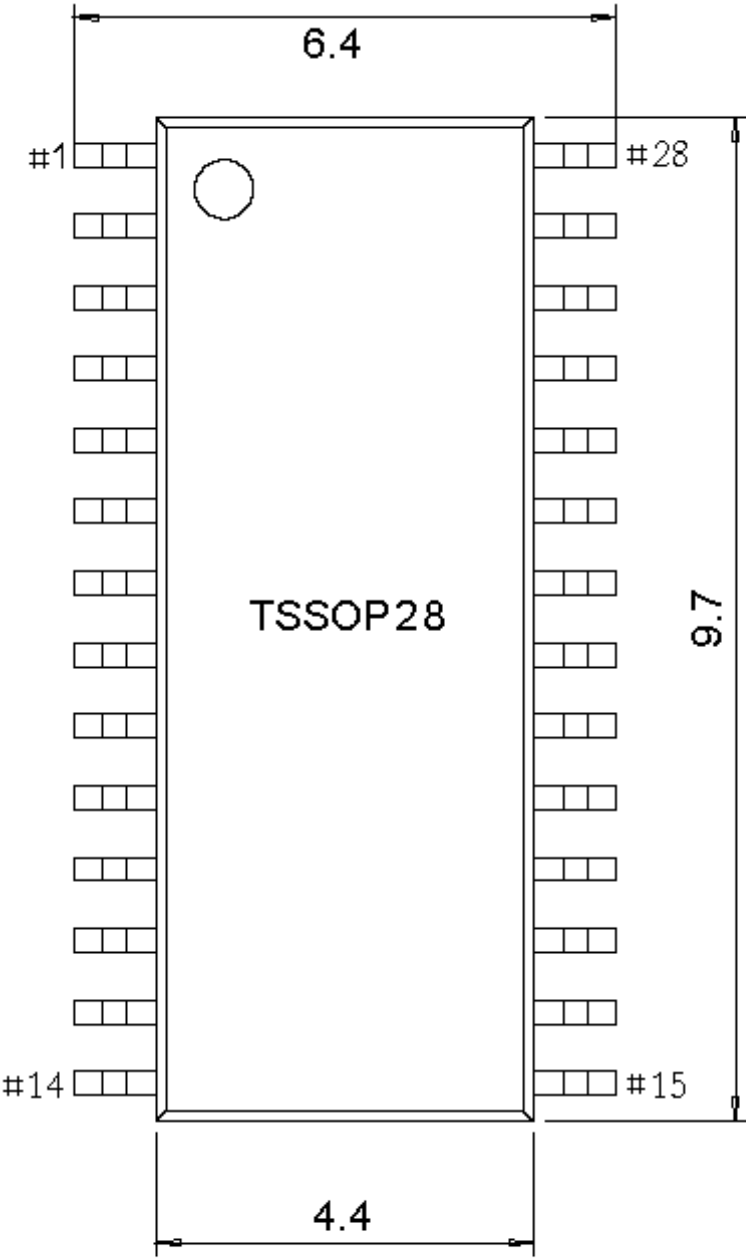



QSOP 类 (3.9mm, 150mil)

QSOP16 (SSOP16-150mil-0.635)

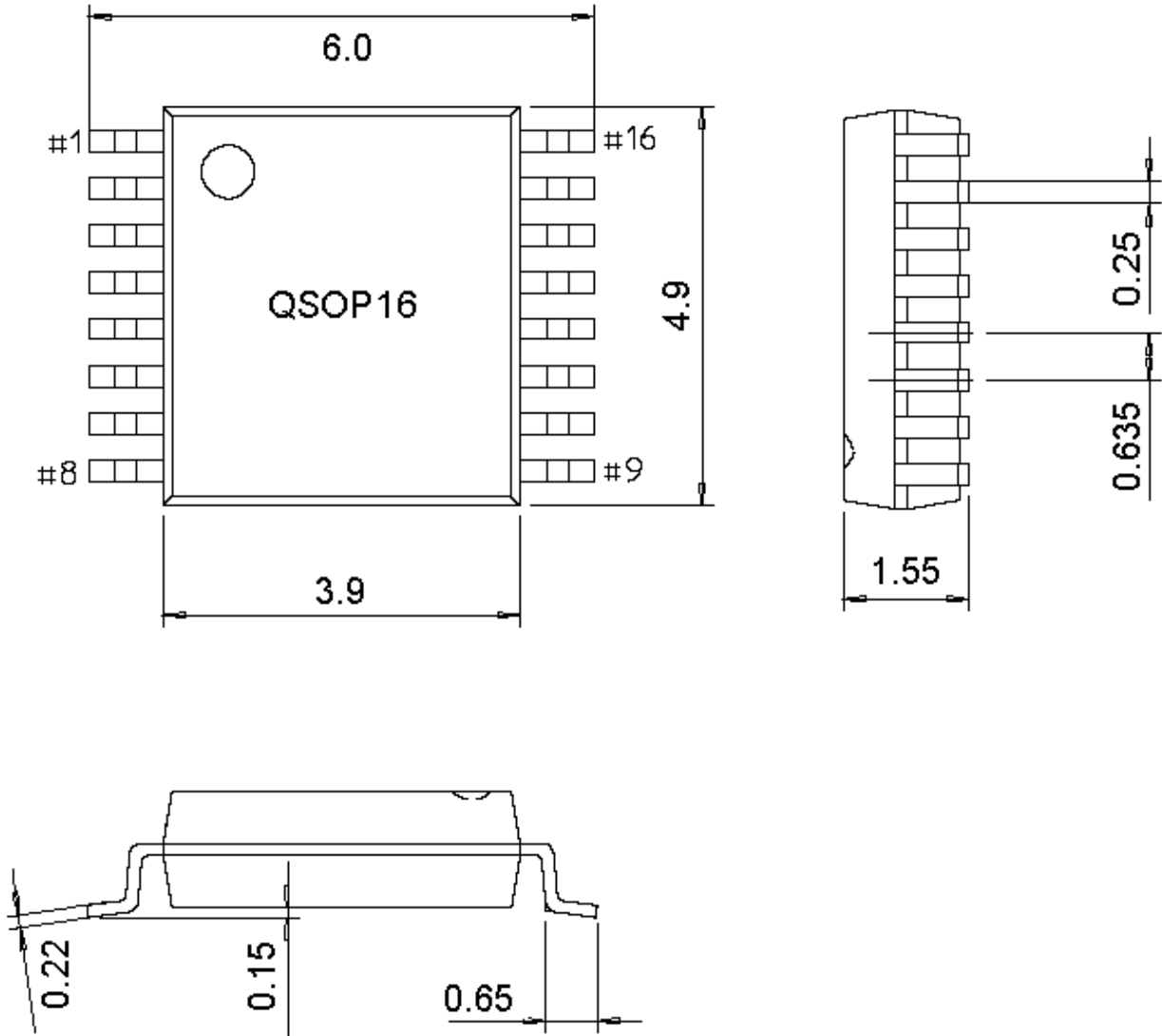

QSOP20 (SSOP20-150mil-0.635)

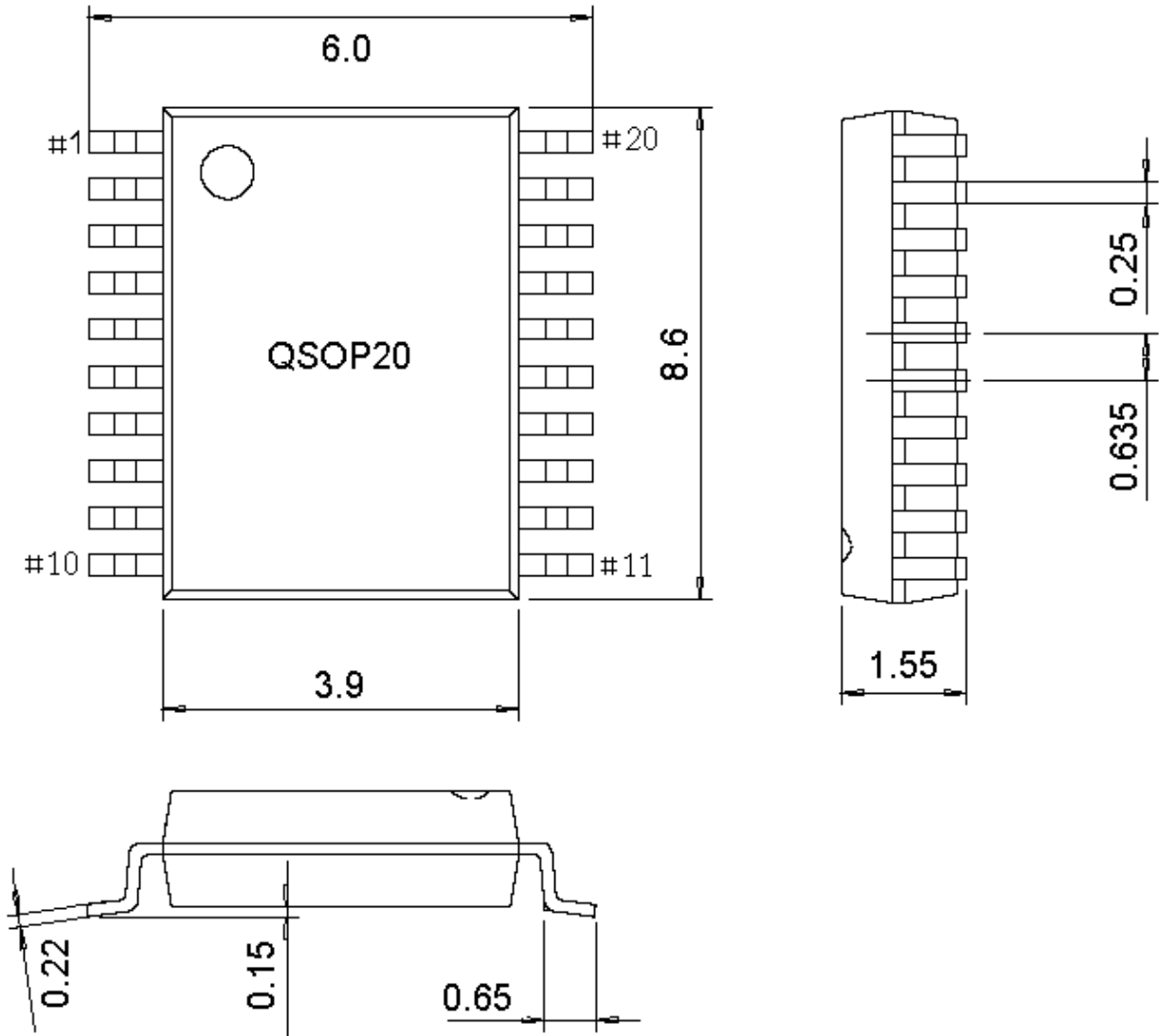

QSOP24 (SSOP24-150mil-0.635)

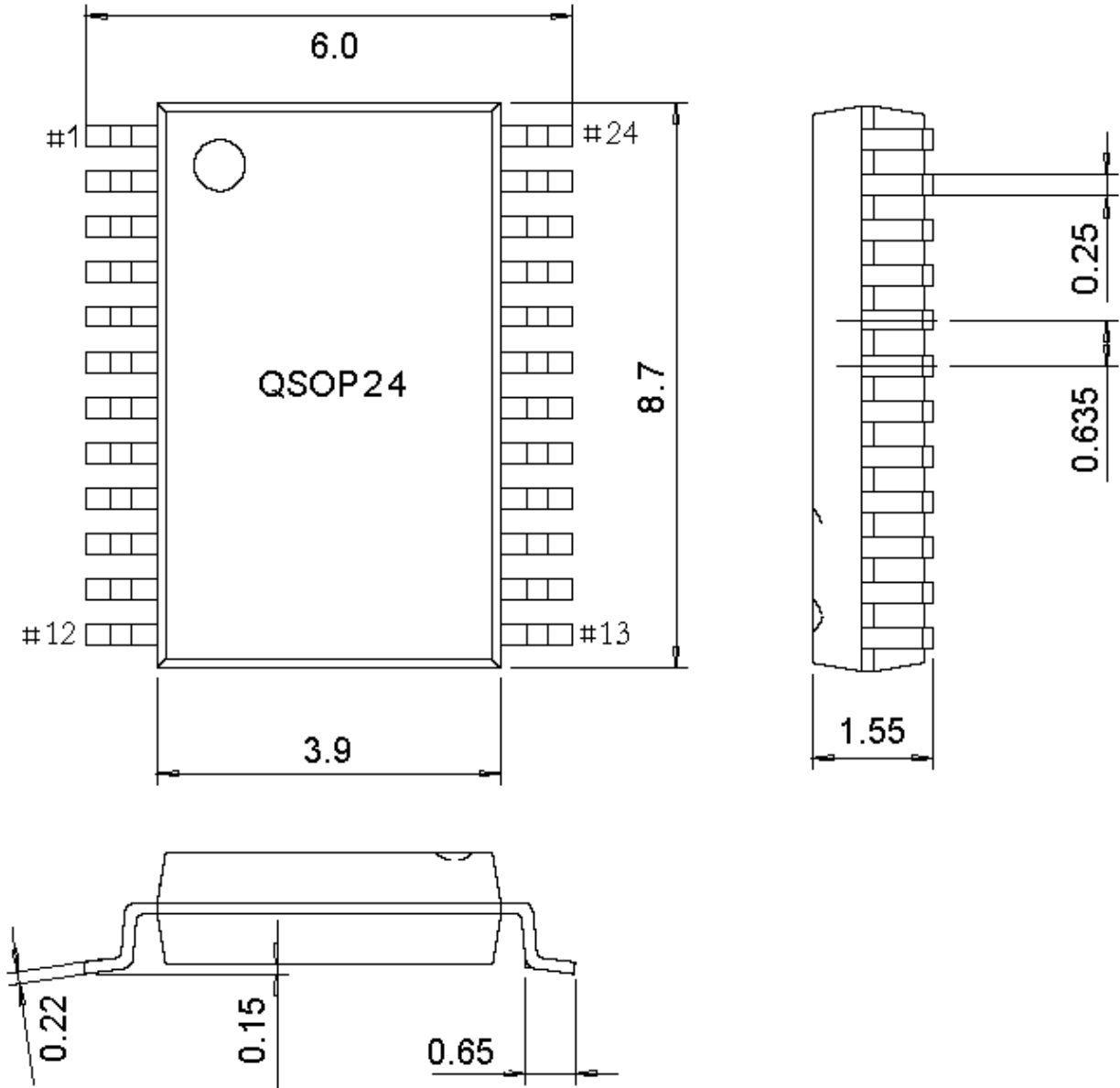

QSOP28 (SSOP28-150mil-0.635)

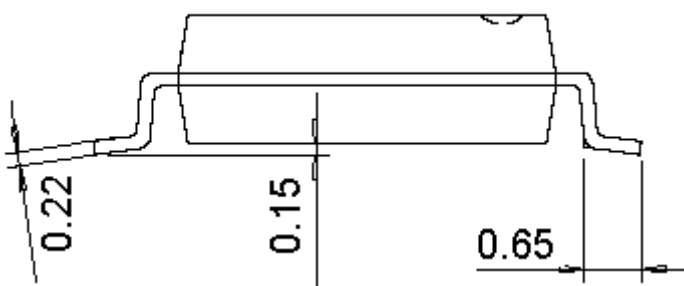
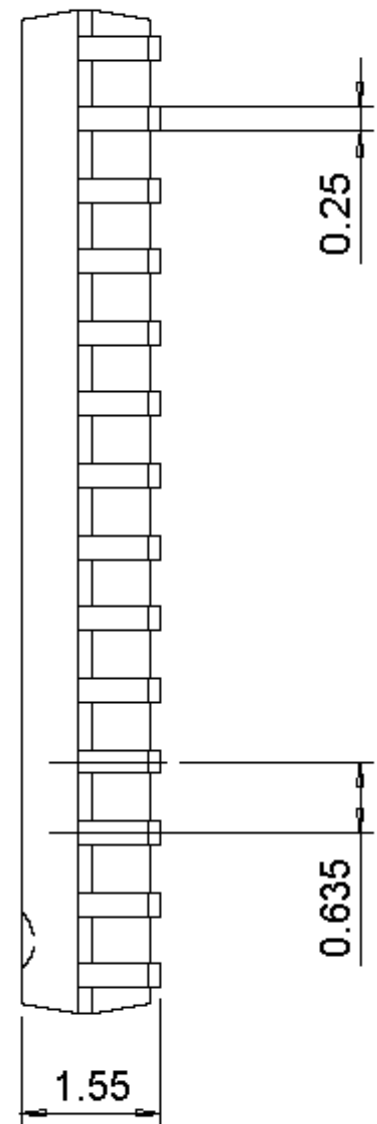
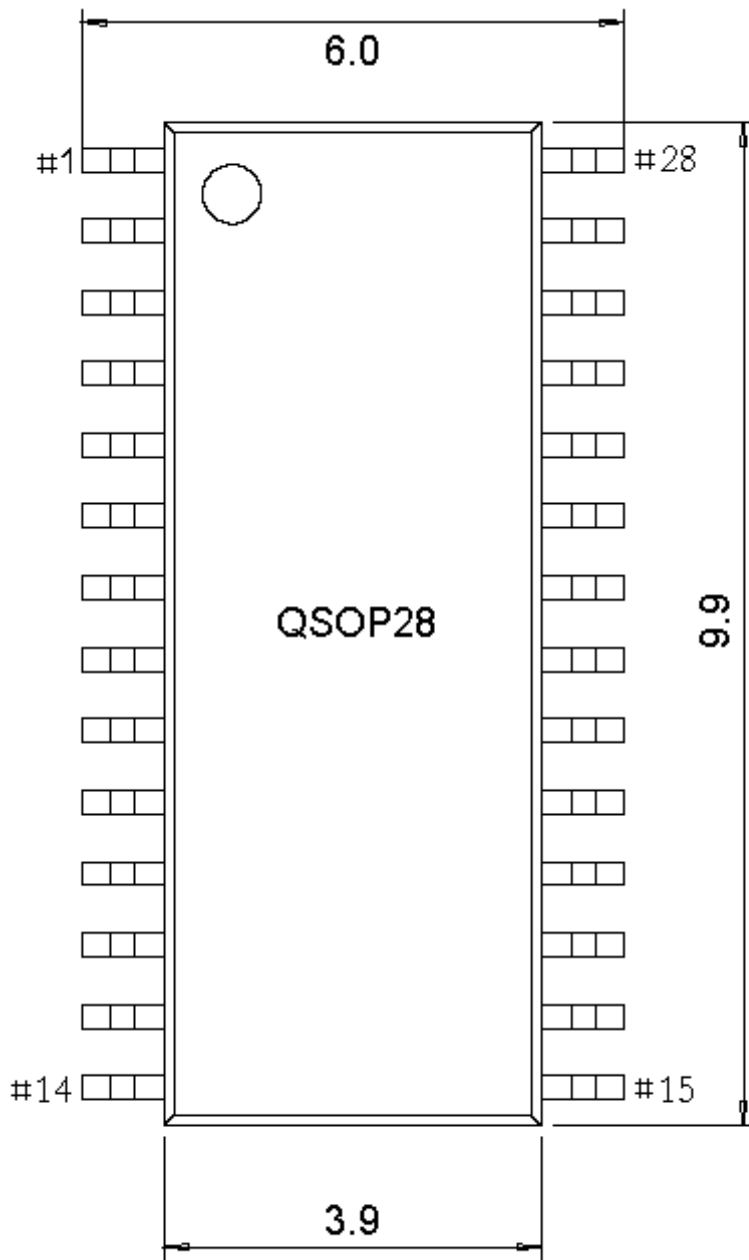

QFP 类 (PQFP、LQFP、TQFP)

PQFP44 (QFP44)

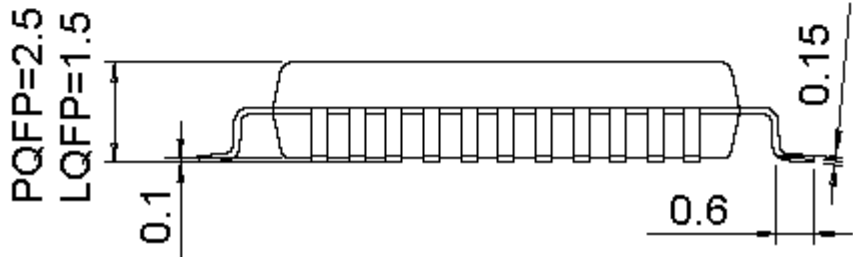
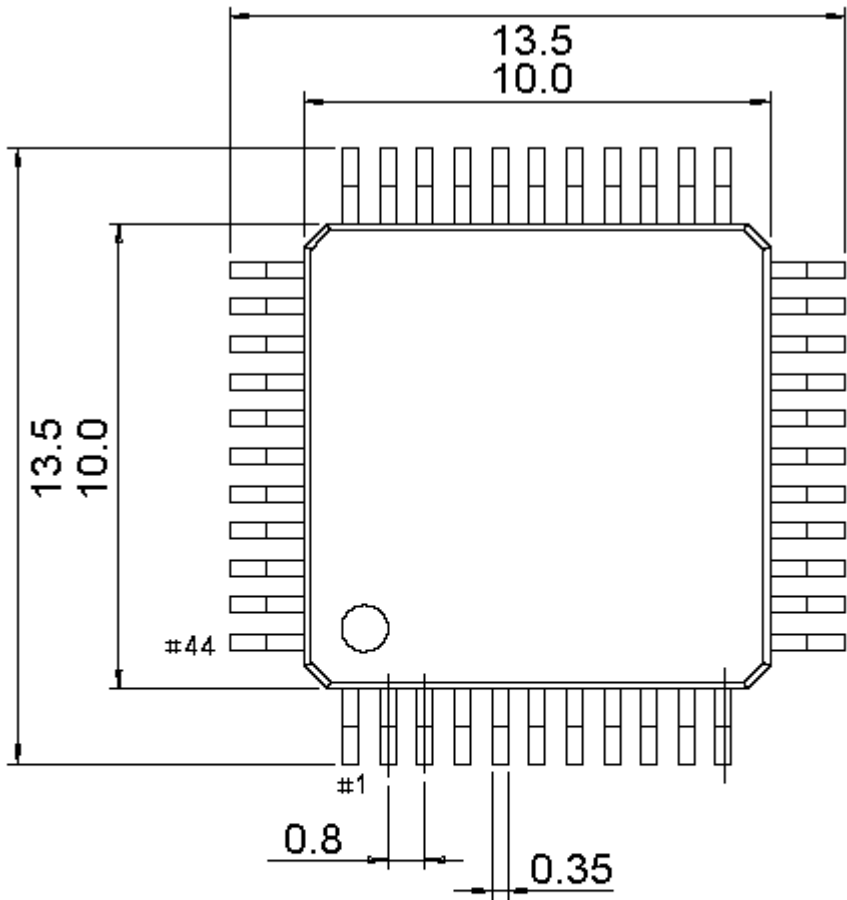

PQFP52 (QFP52)

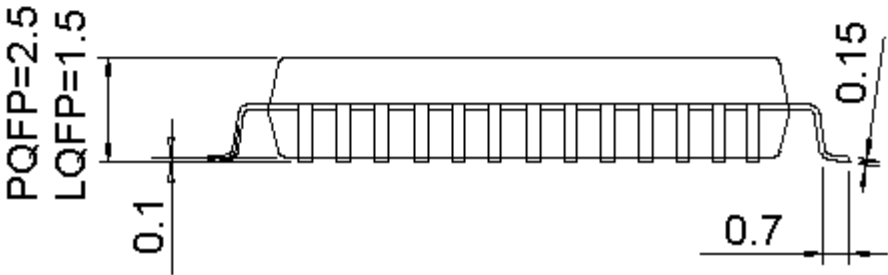
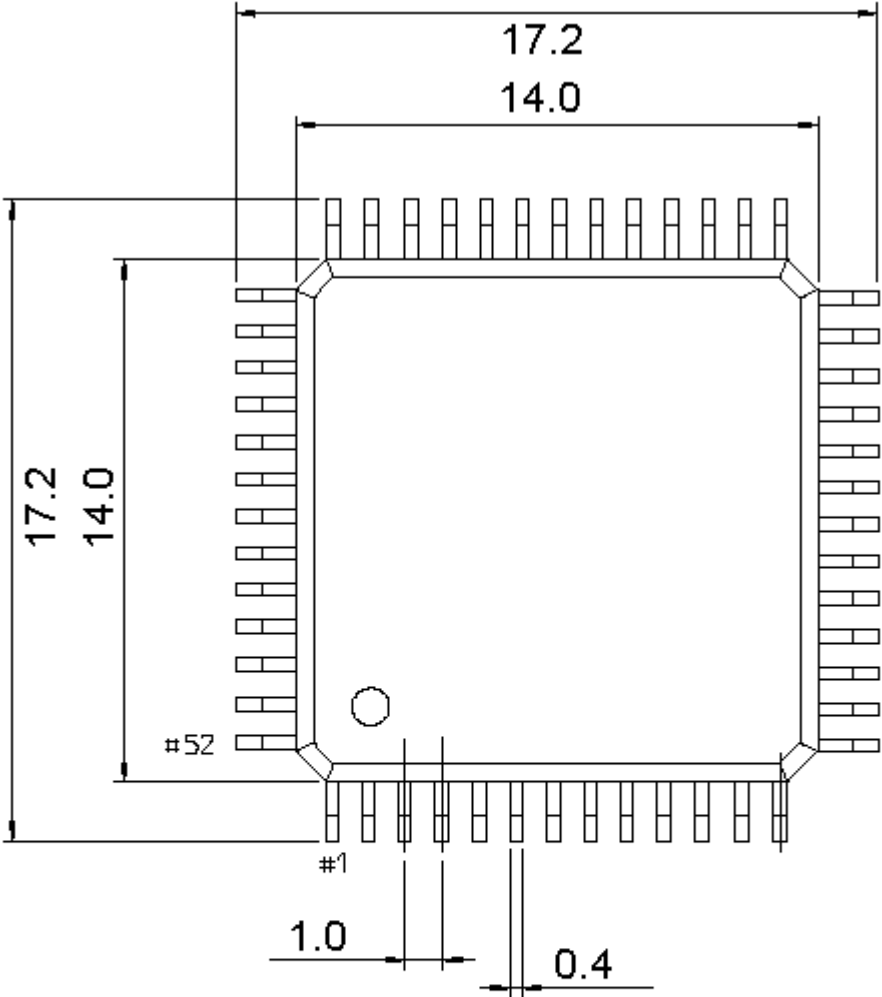

PQFP64 (QFP64)、LQFP64-14\*14

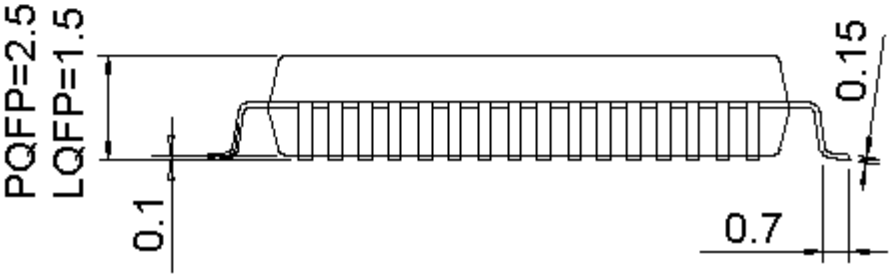
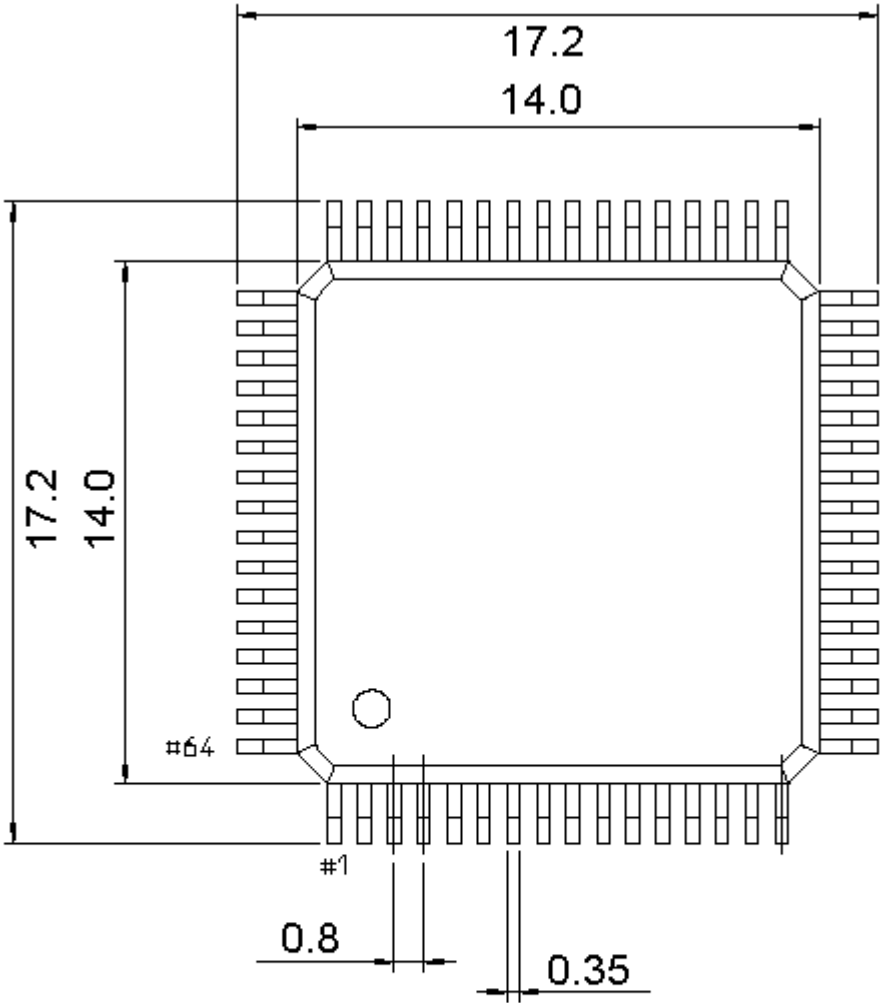

PQFP80 (QFP80)

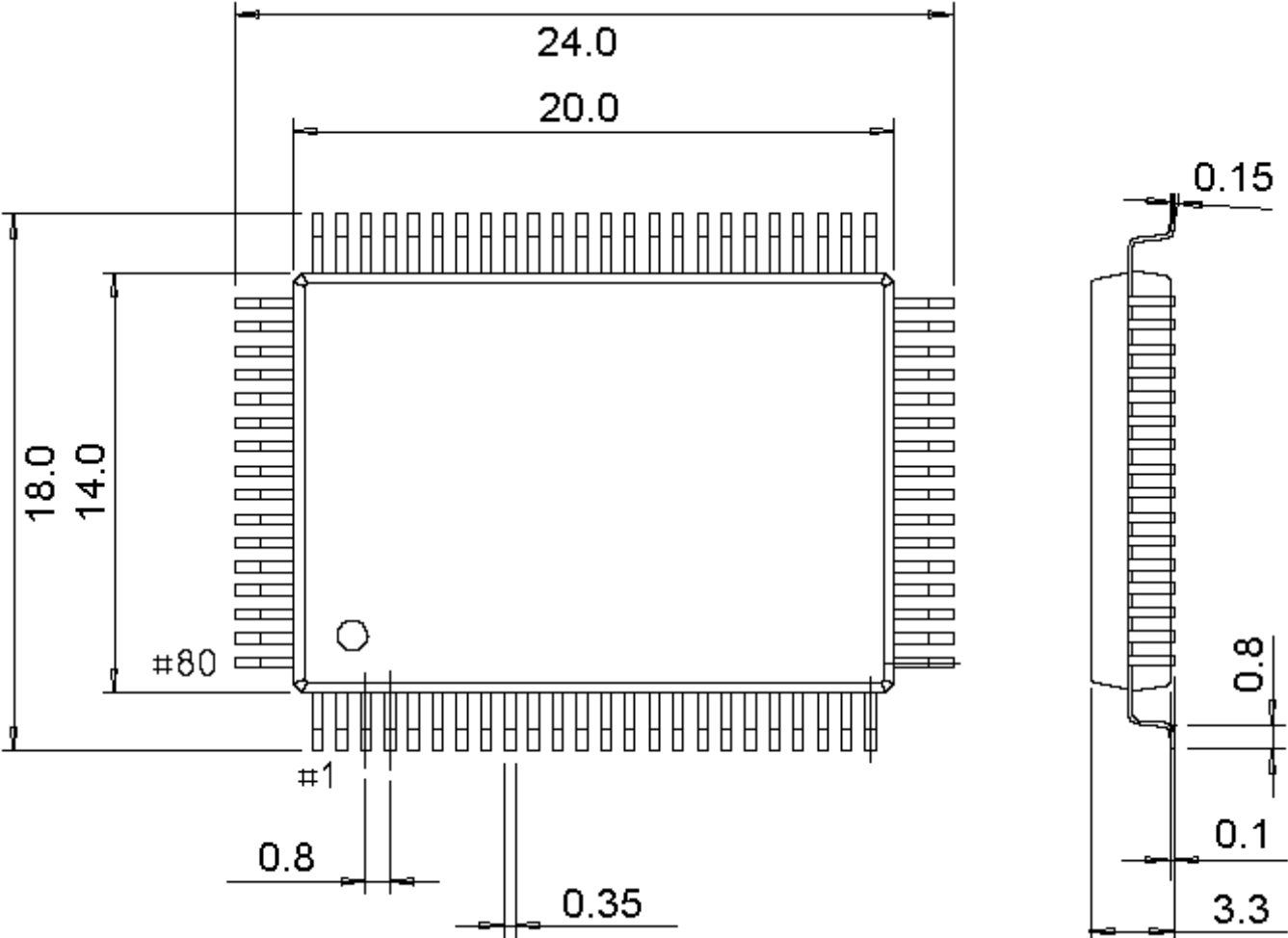



LQFP32 (LQFP32-7\*7)

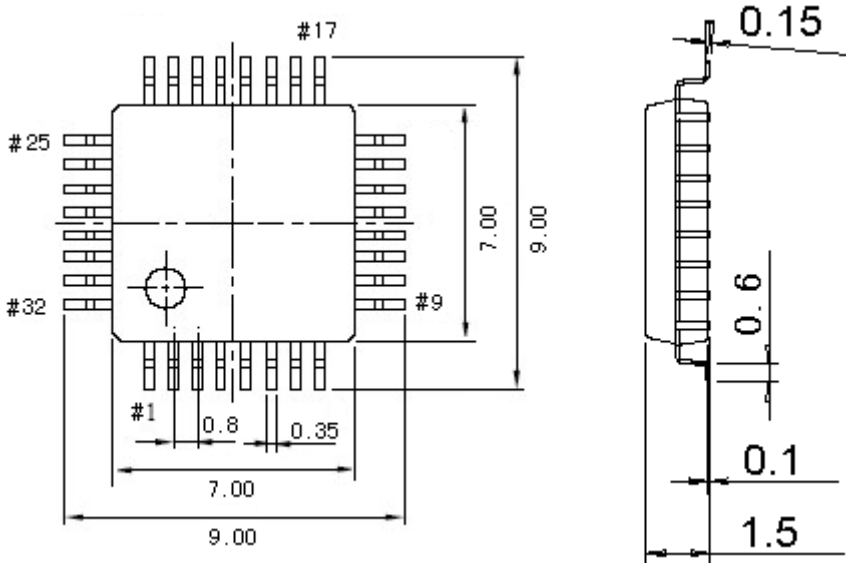

LQFP44 (LQFP44-10\*10)

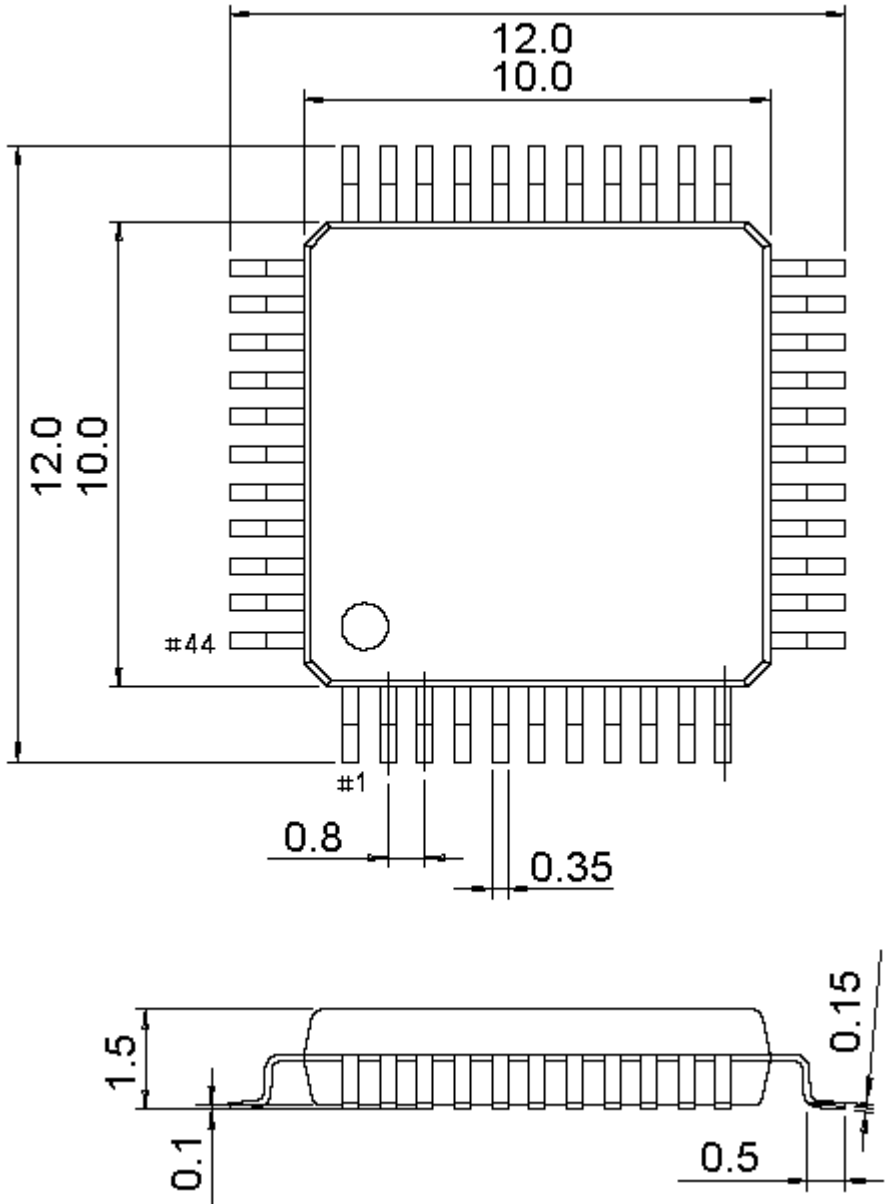

LQFP48 (LQFP48-7\*7)、TQFP48、eLQFP48

eLQFP48 Exposed Pad: 3.2\*3.2

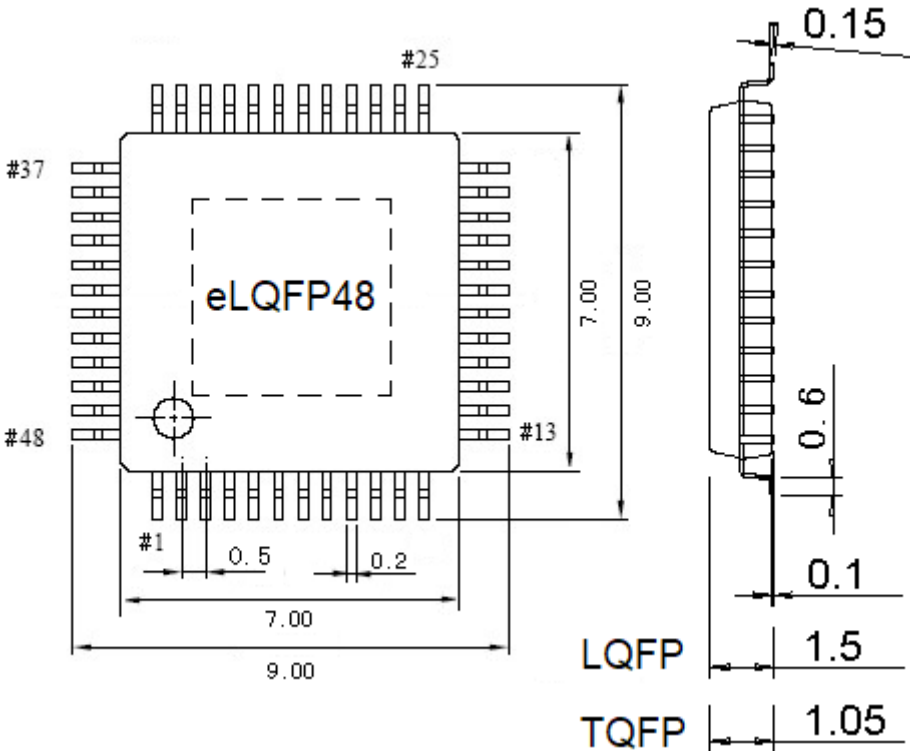

LQFP64 (LQFP64-7\*7)、TQFP64

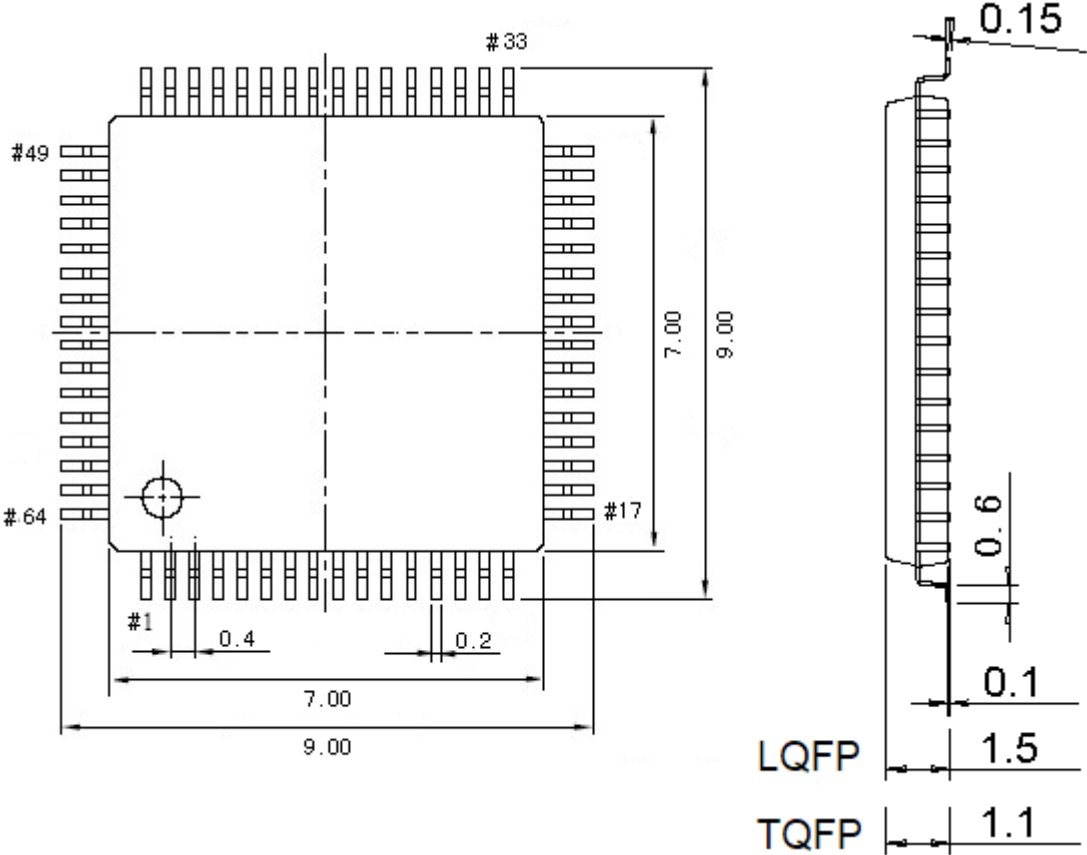

LQFP64M (LQFP64-10\*10)

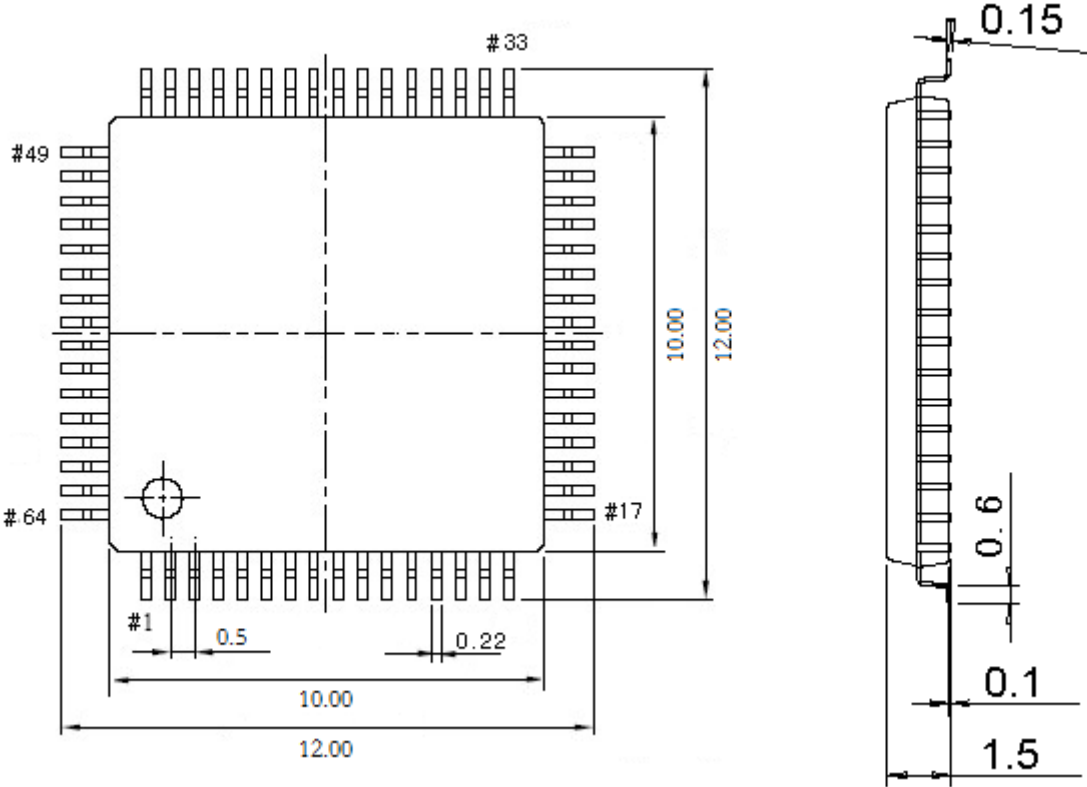

LQFP80 (LQFP80-12\*12)

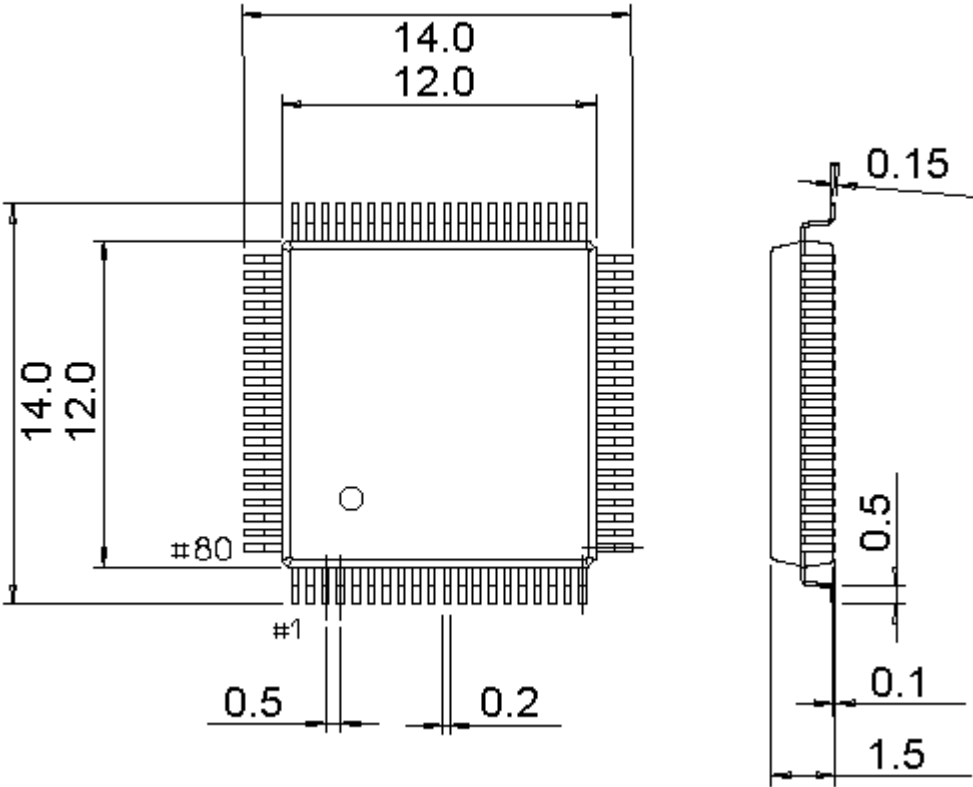

LQFP100 (LQFP100-14\*14)

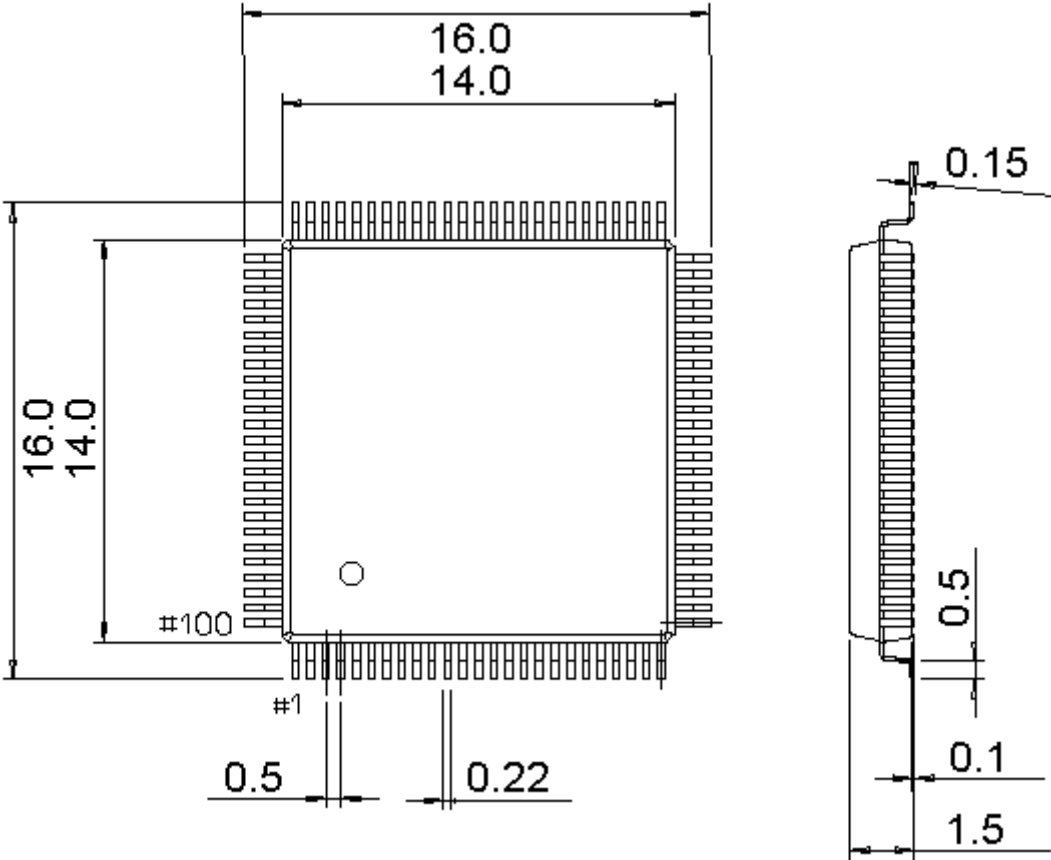

LQFP128 (LQFP128-14\*14)

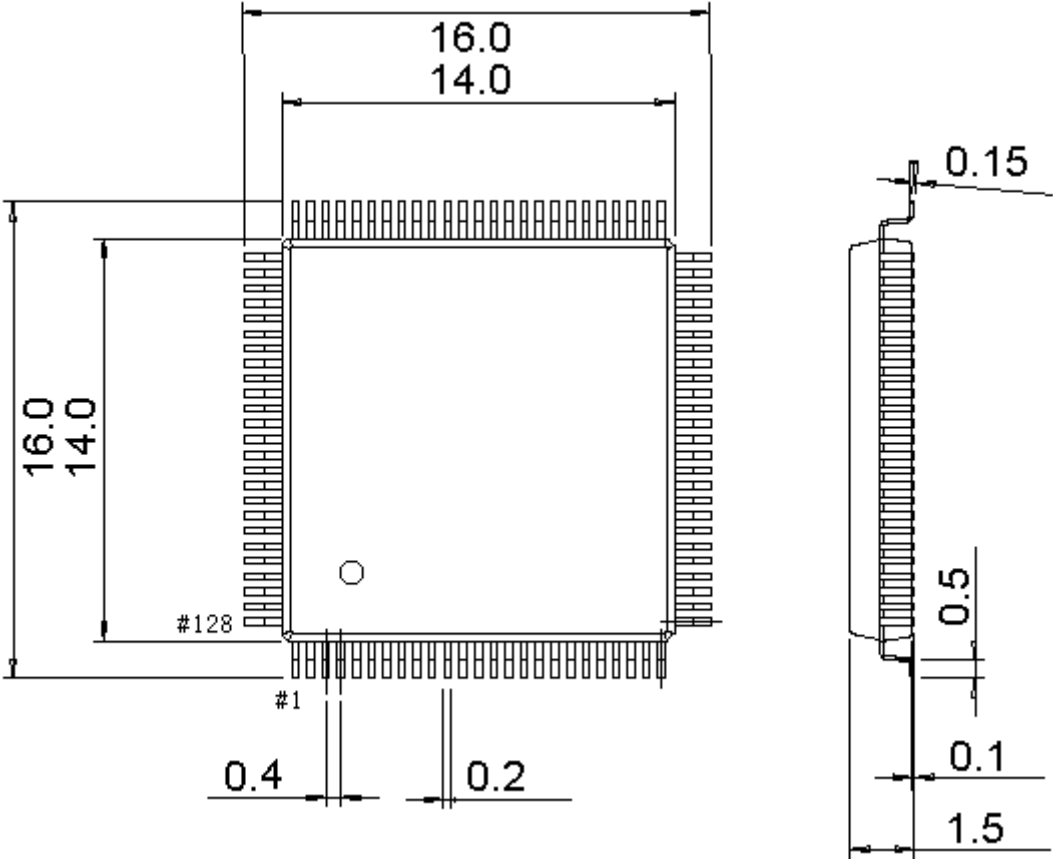



LQFP144 (LQFP144-20\*20)

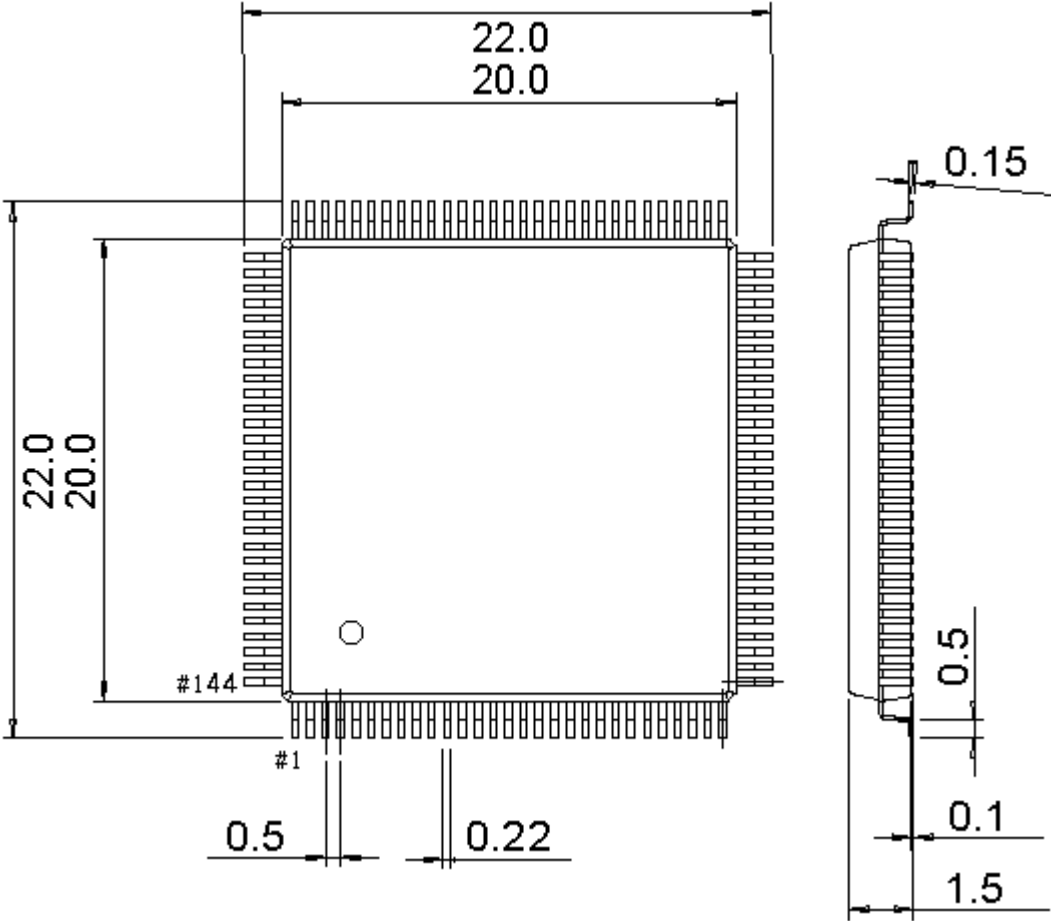

### QFN 类

QFN12 (QFN12-2\*2)

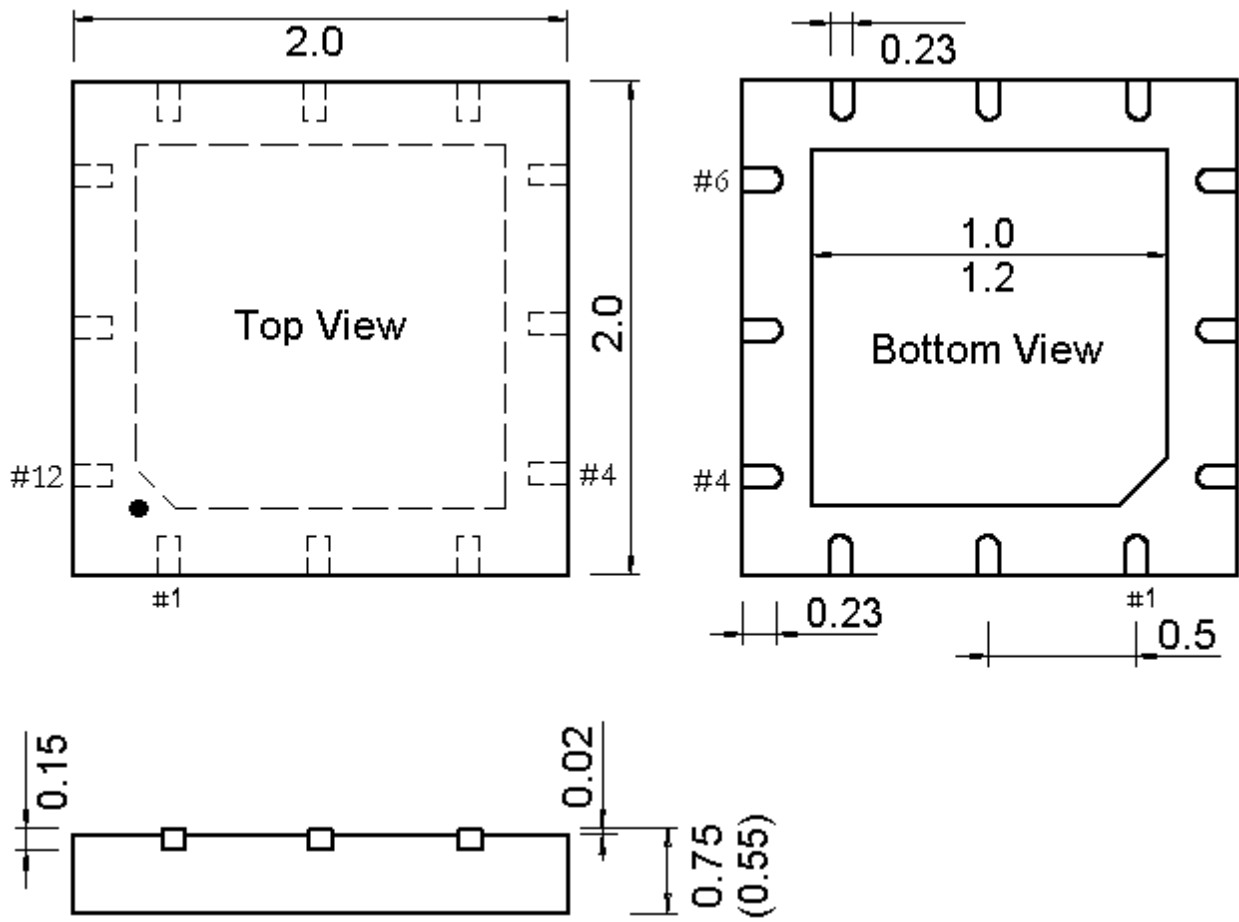

QFN16 (QFN16-3\*3)

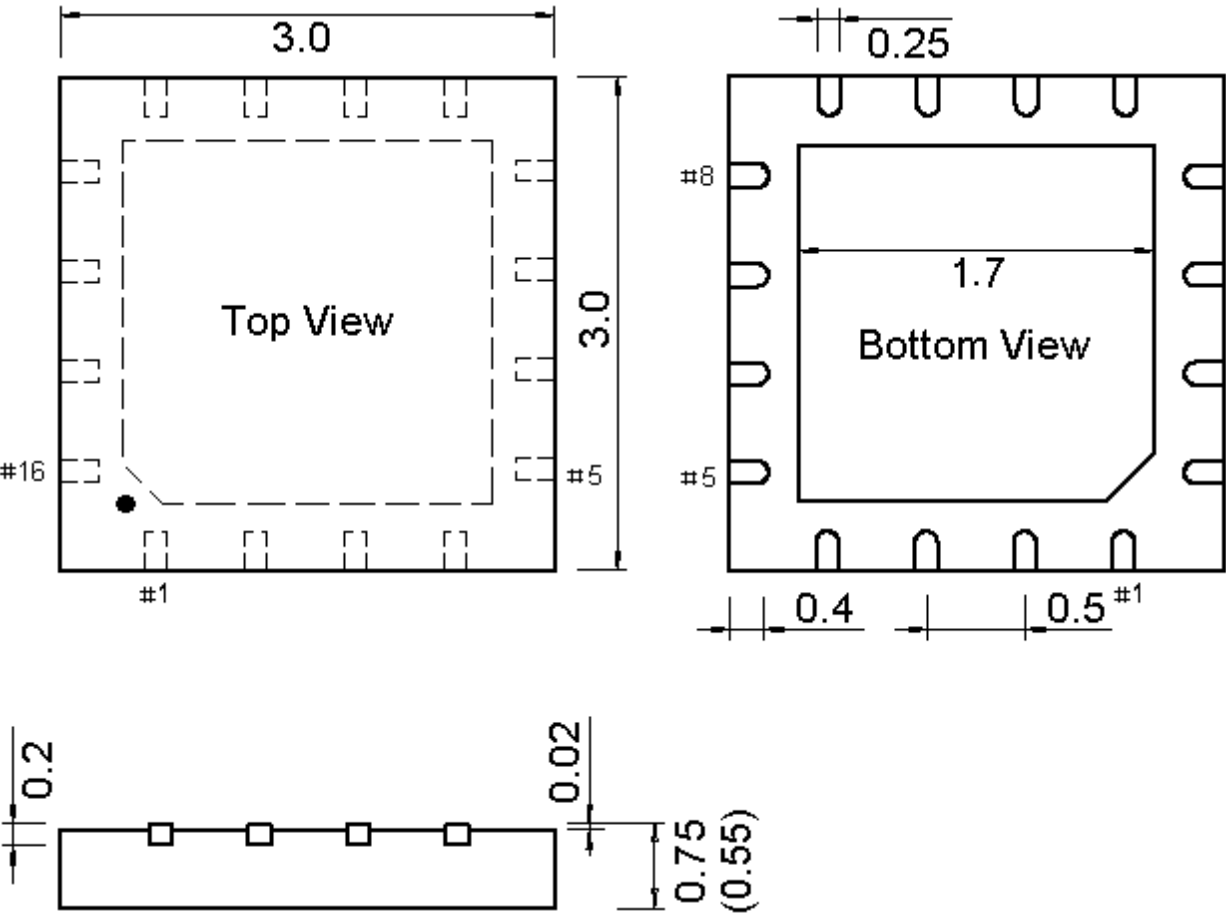

QFN16X4 (QFN16-4\*4)

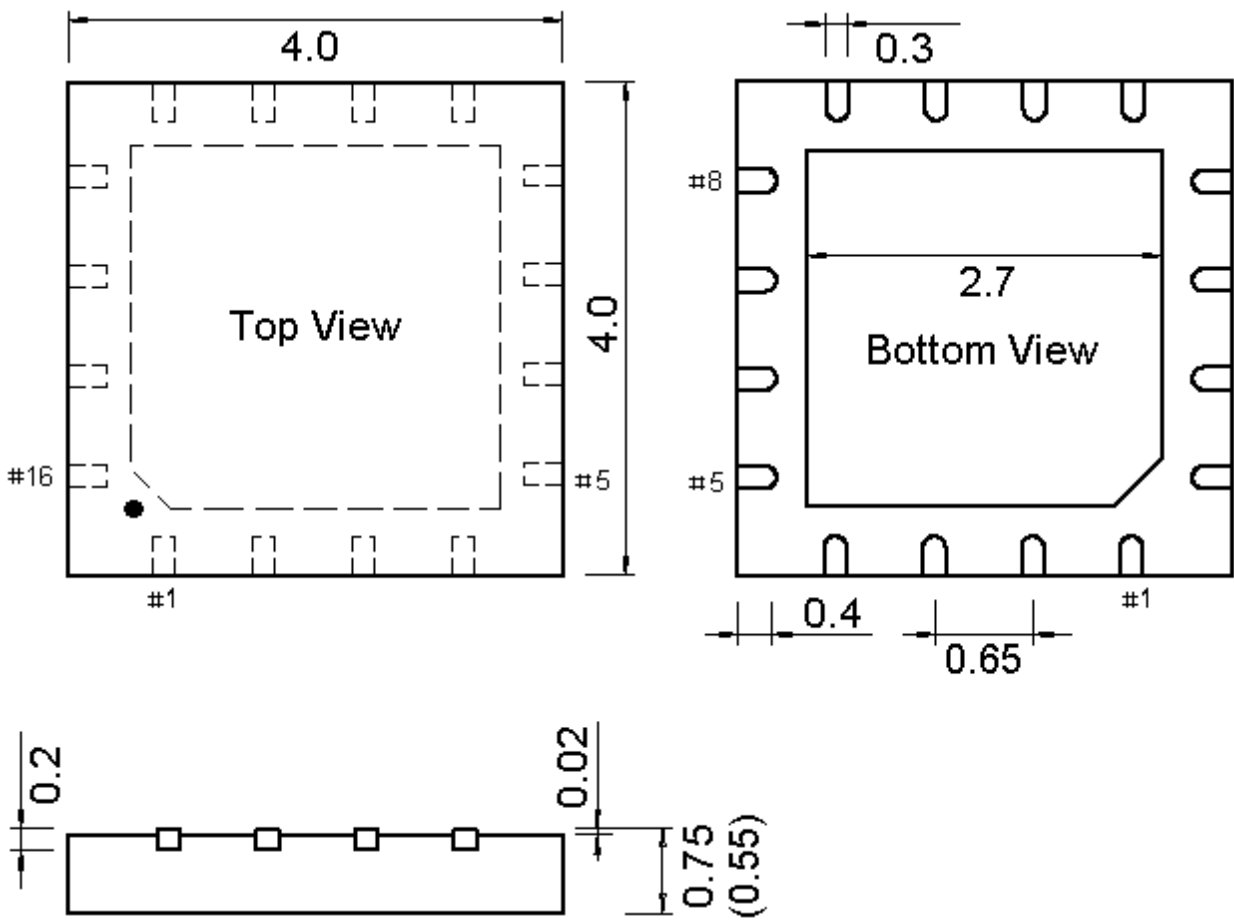

QFN20 (QFN20-3\*3)

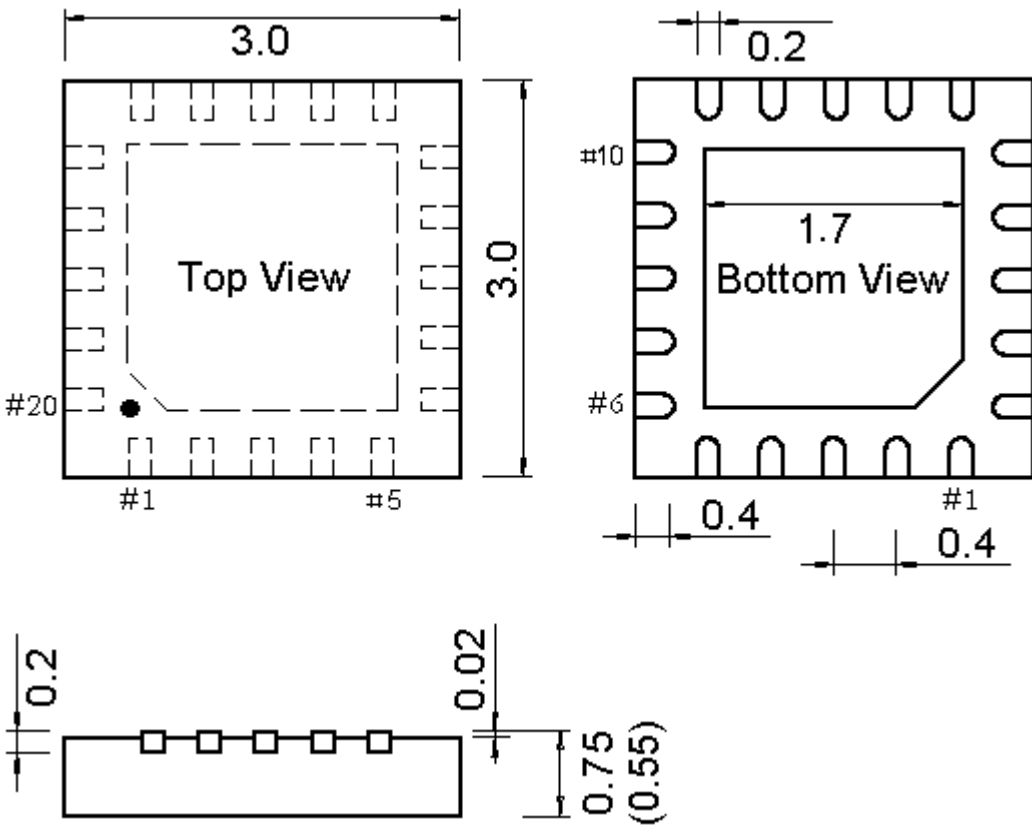

QFN20X4 (QFN20-4\*4)

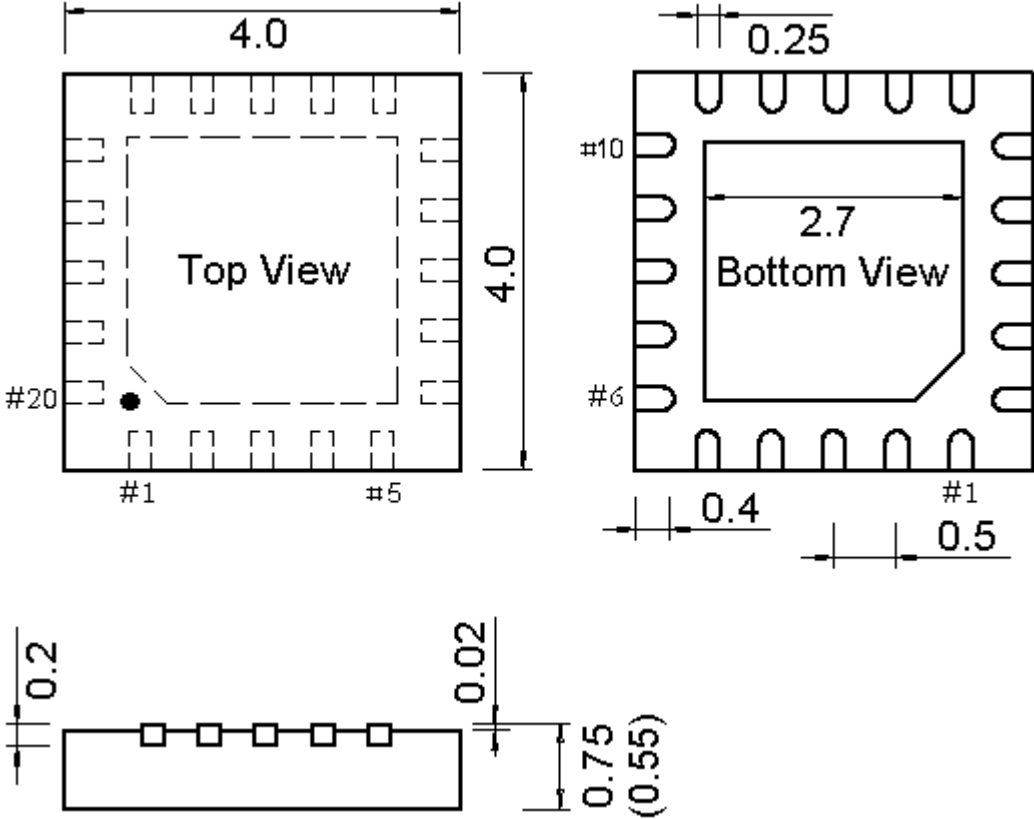



QFN24 (QFN24-4\*4)

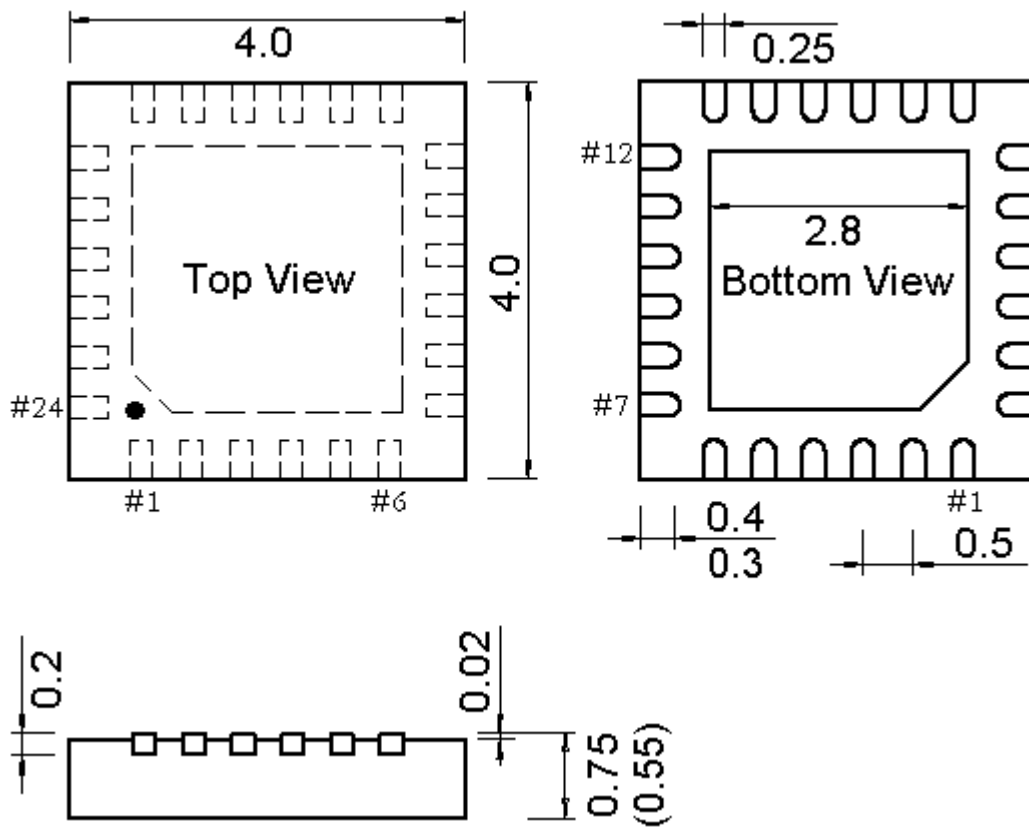



QFN24-3\*3.5

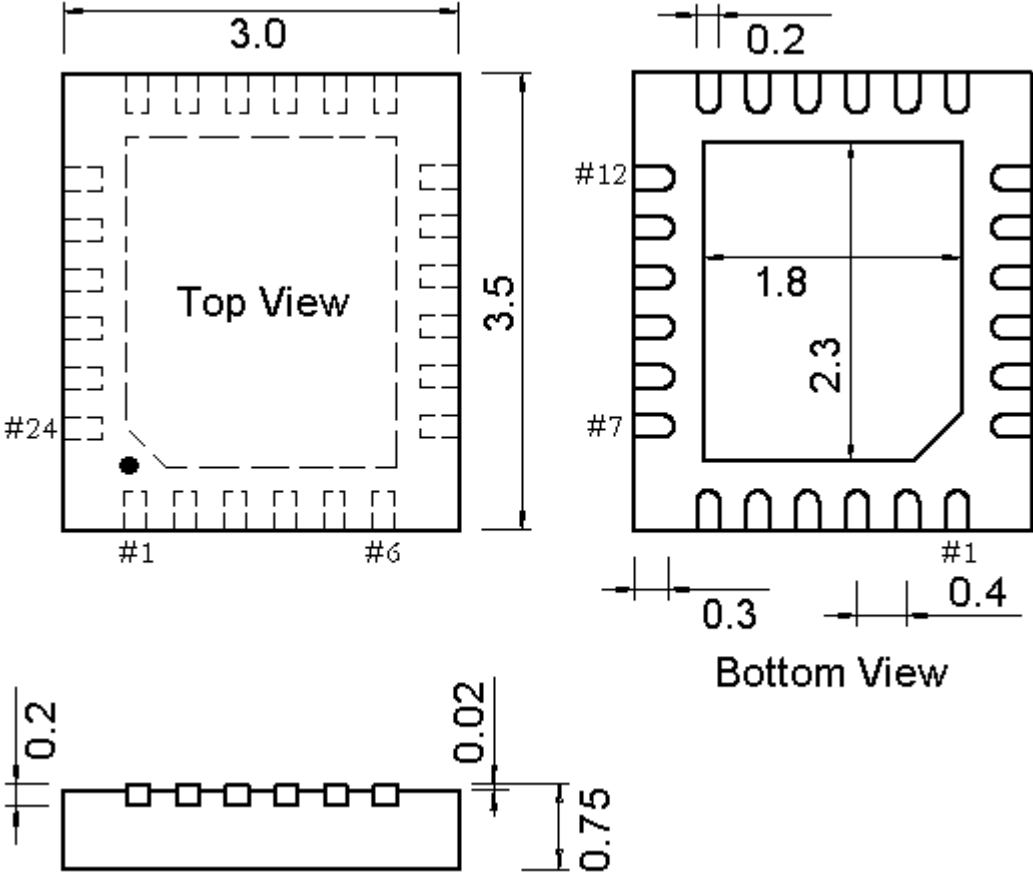

QFN28 (QFN28-4\*4)

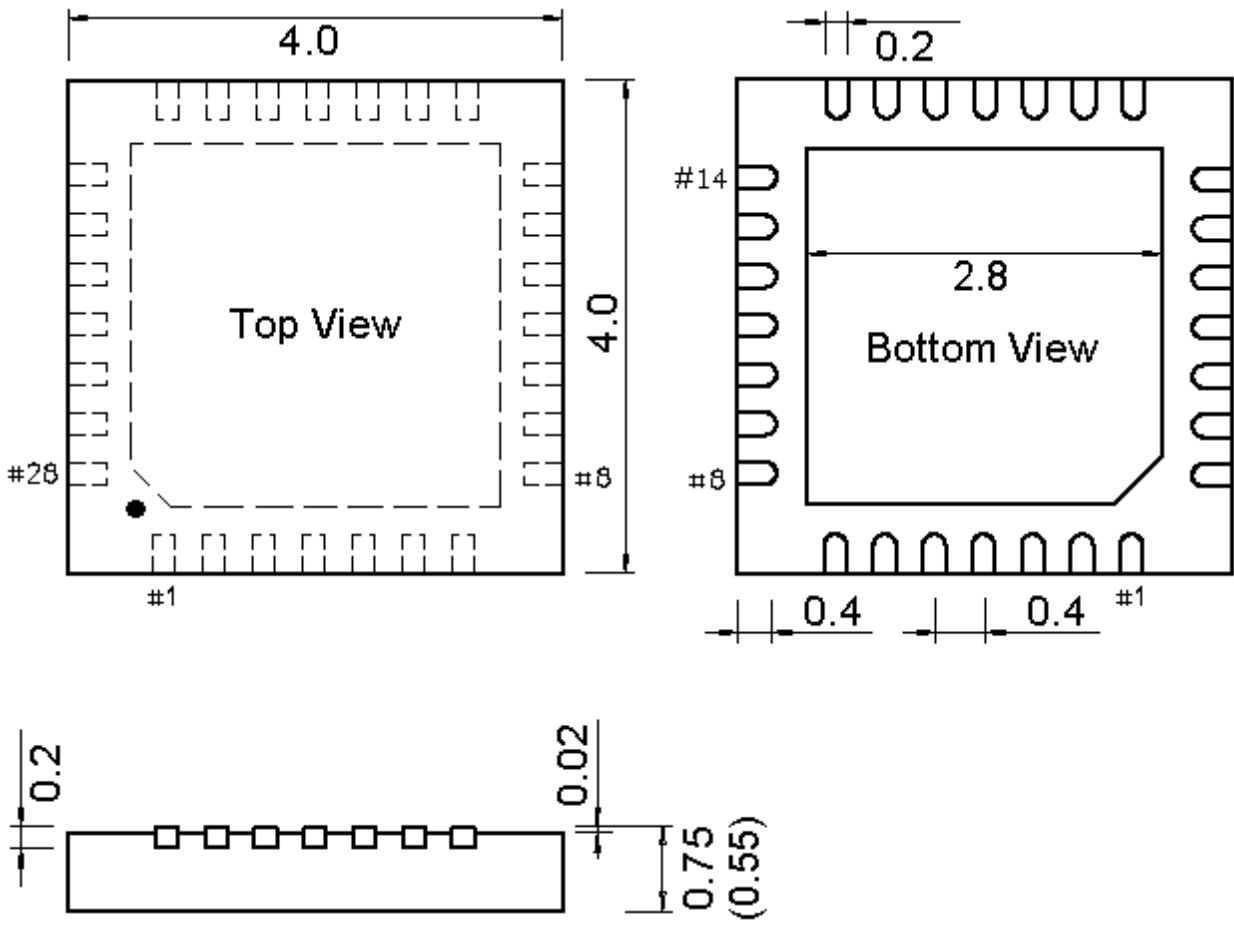

QFN28X5 (QFN28-5\*5)

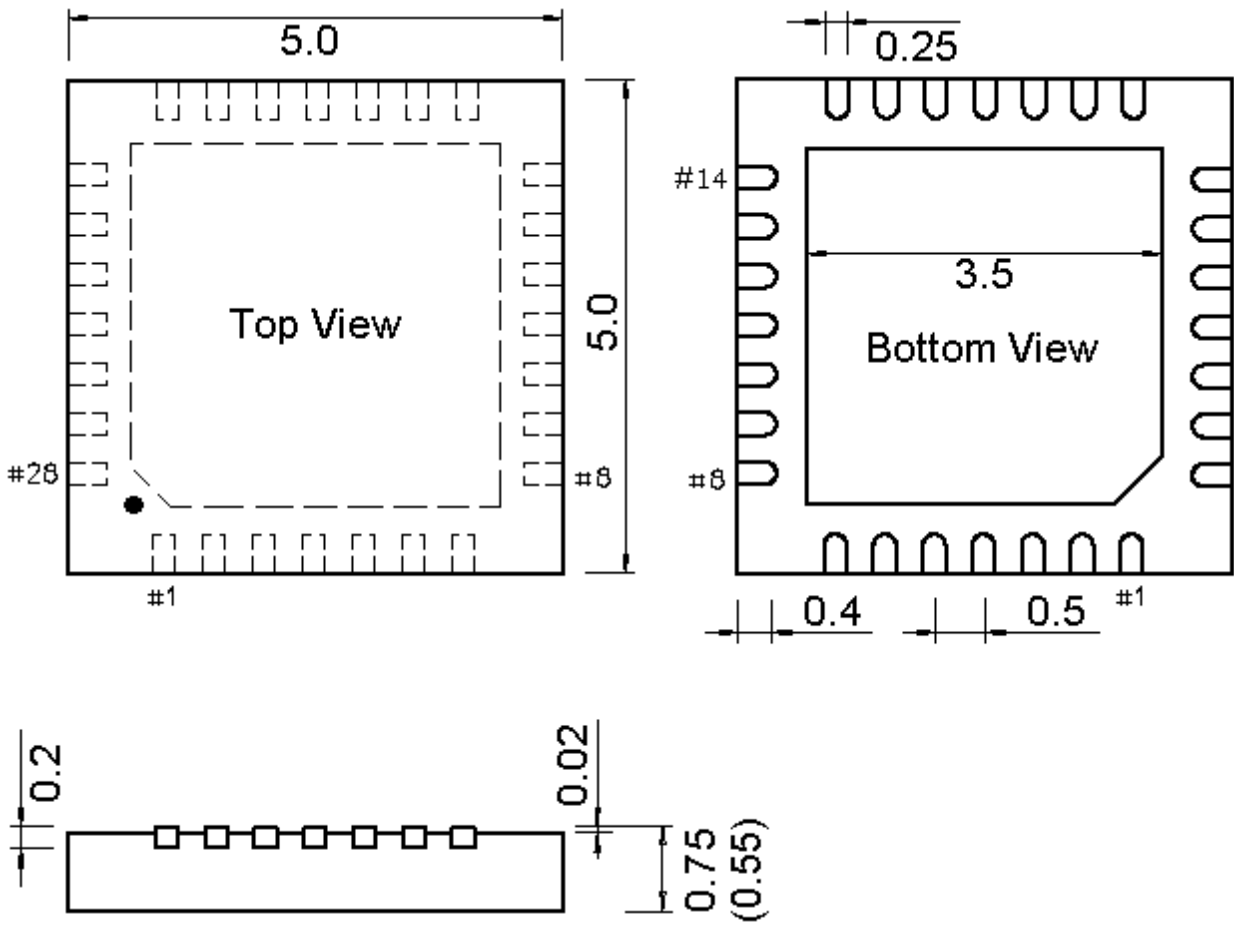

QFN32 (QFN32-4\*4)

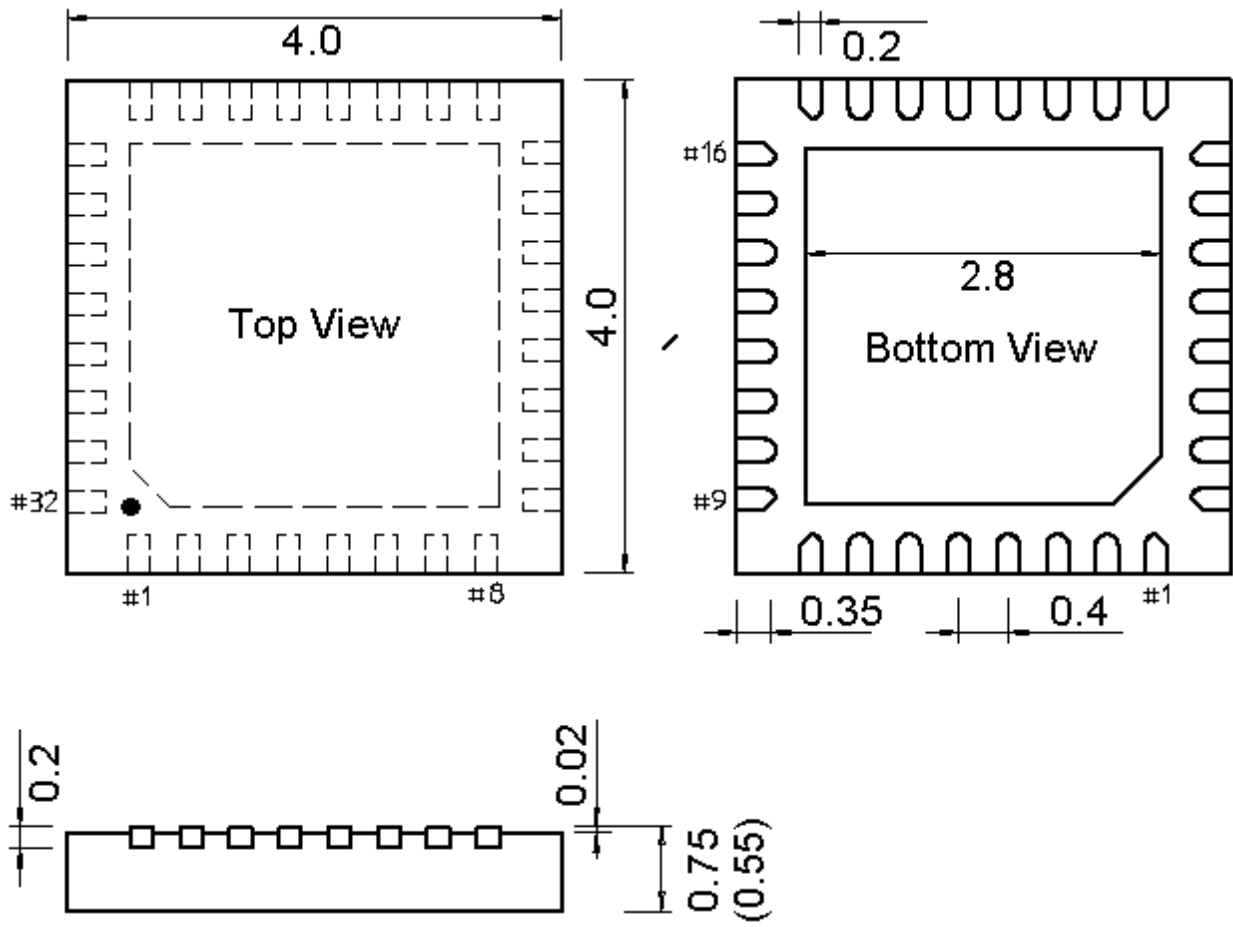

QFN32X5 (QFN32-5\*5)

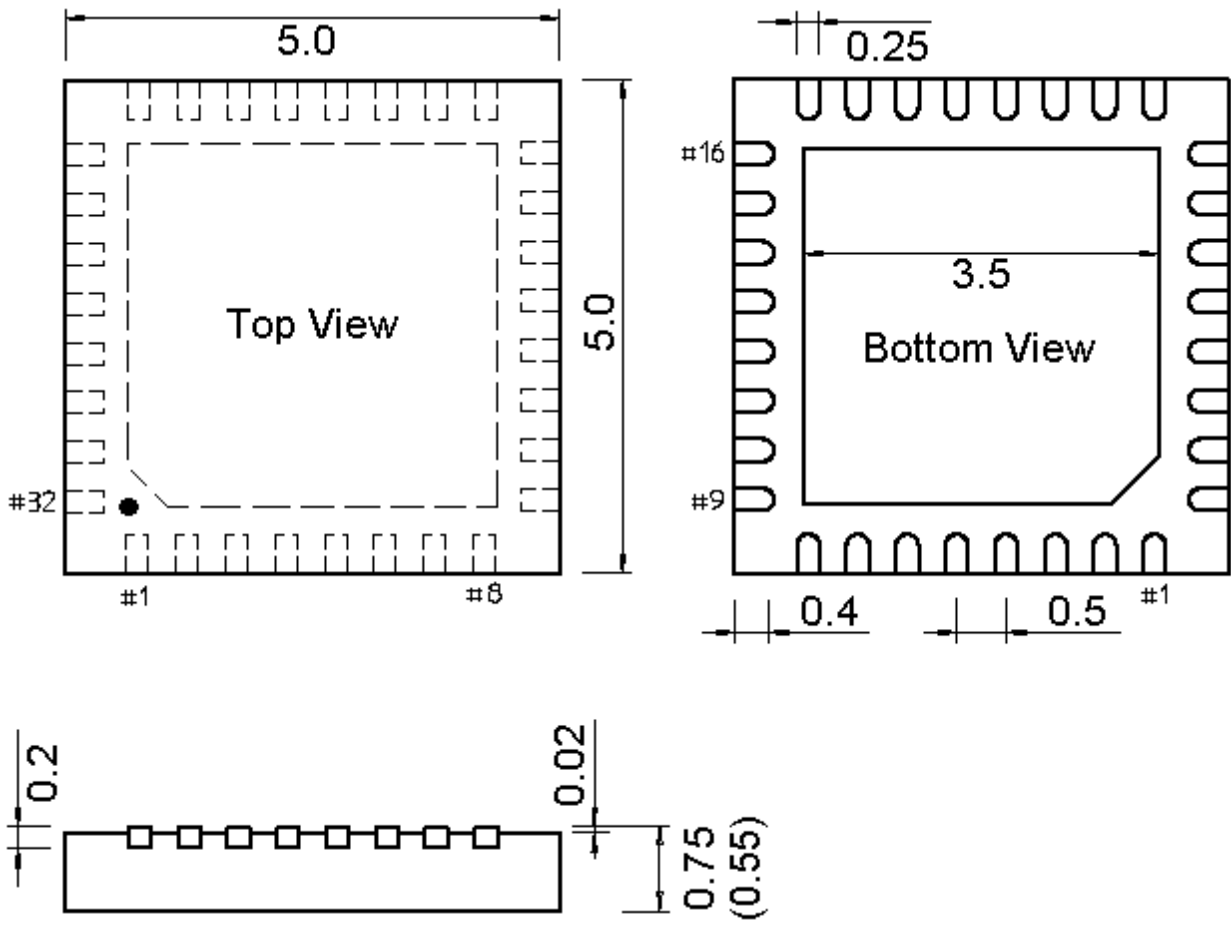

QFN36X6 (QFN36-6\*6)

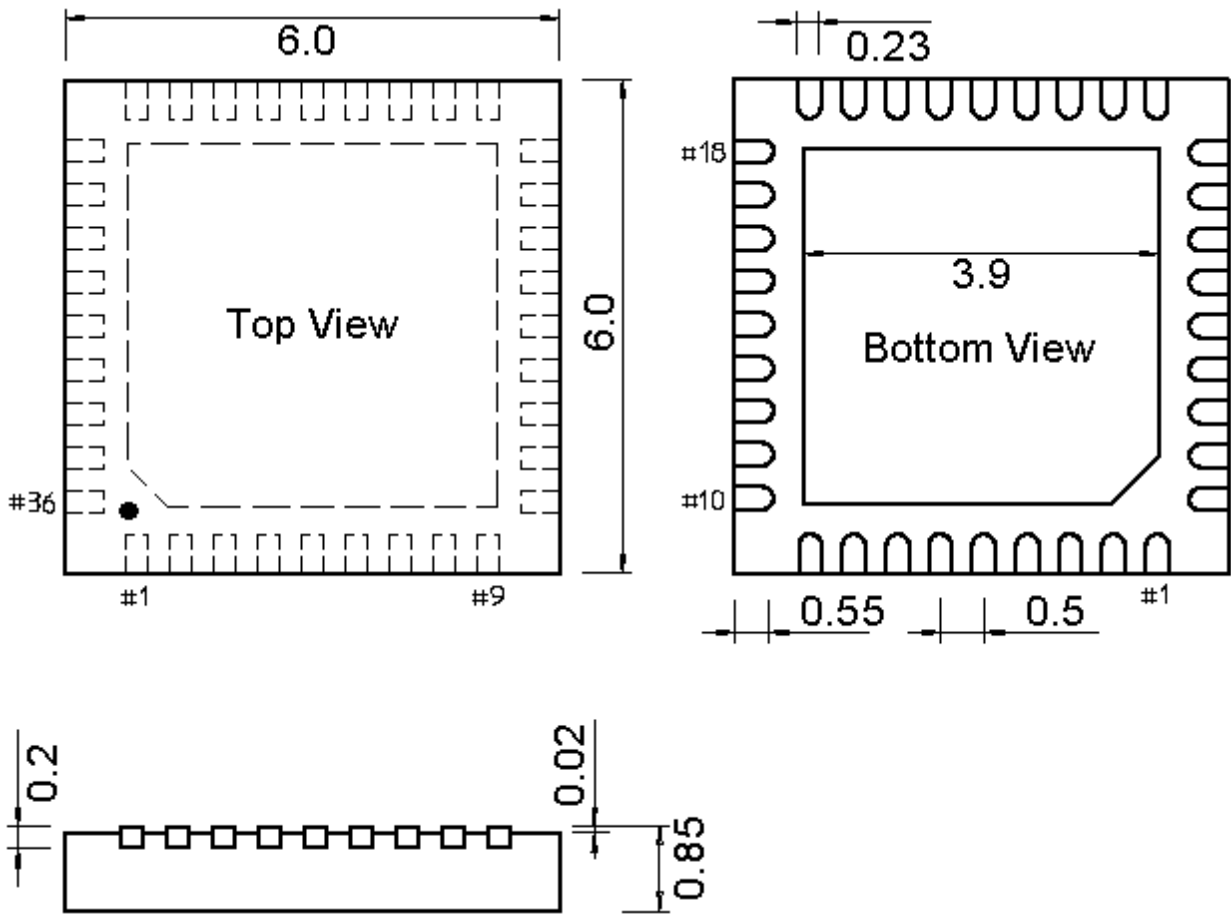

QFN40 (QFN40-5\*5)

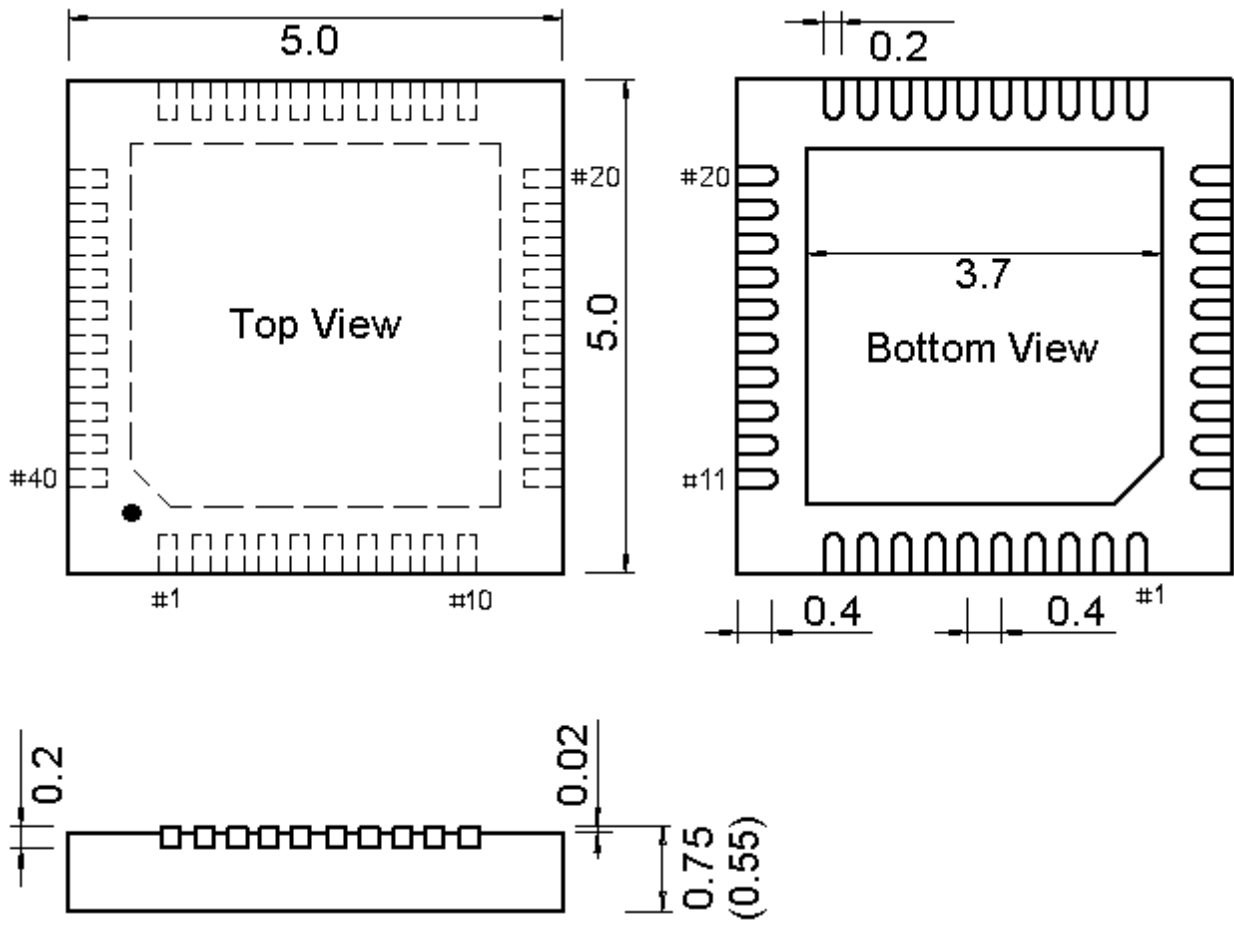

QFN40X6 (QFN40-6\*6)

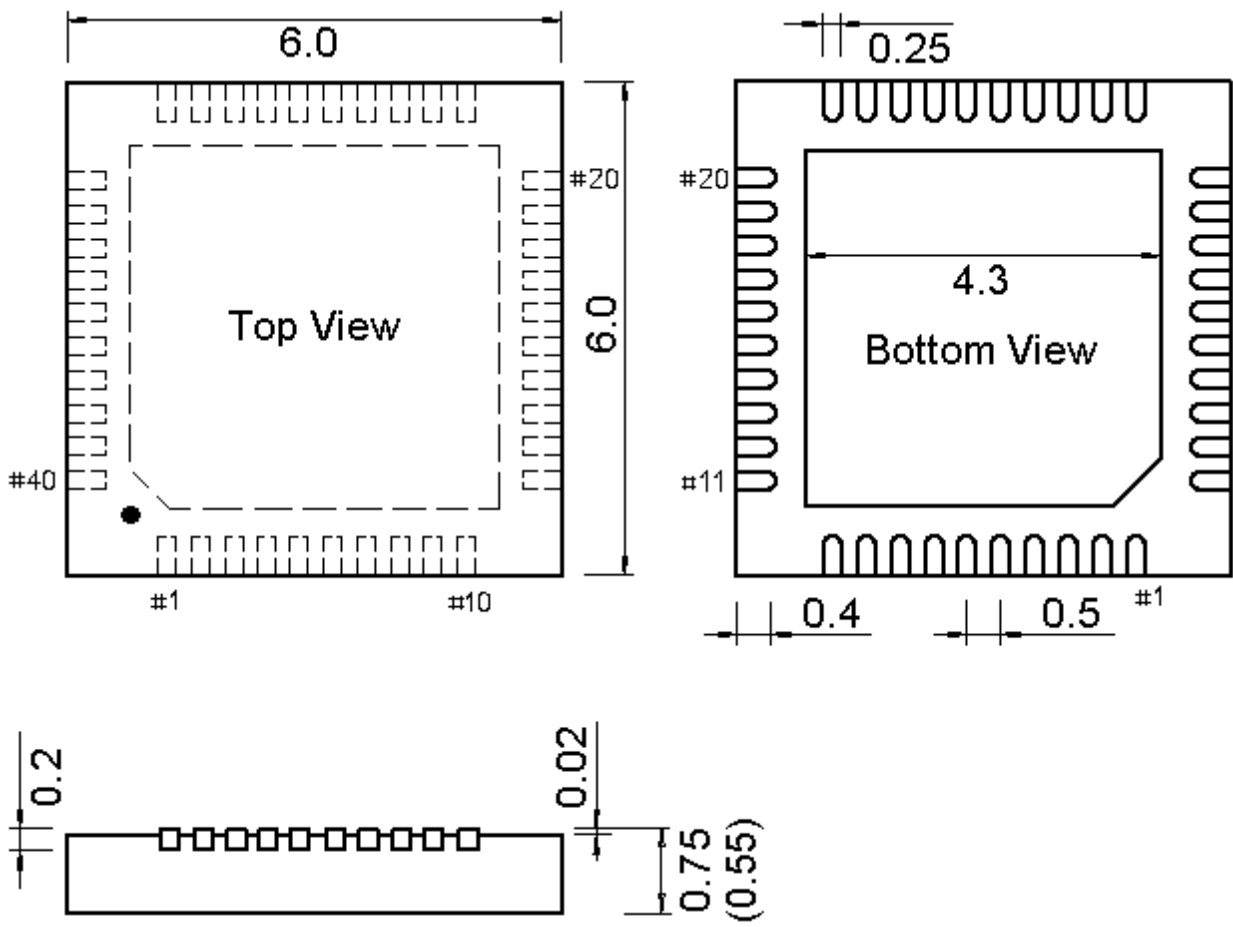



QFN42-3.5\*9

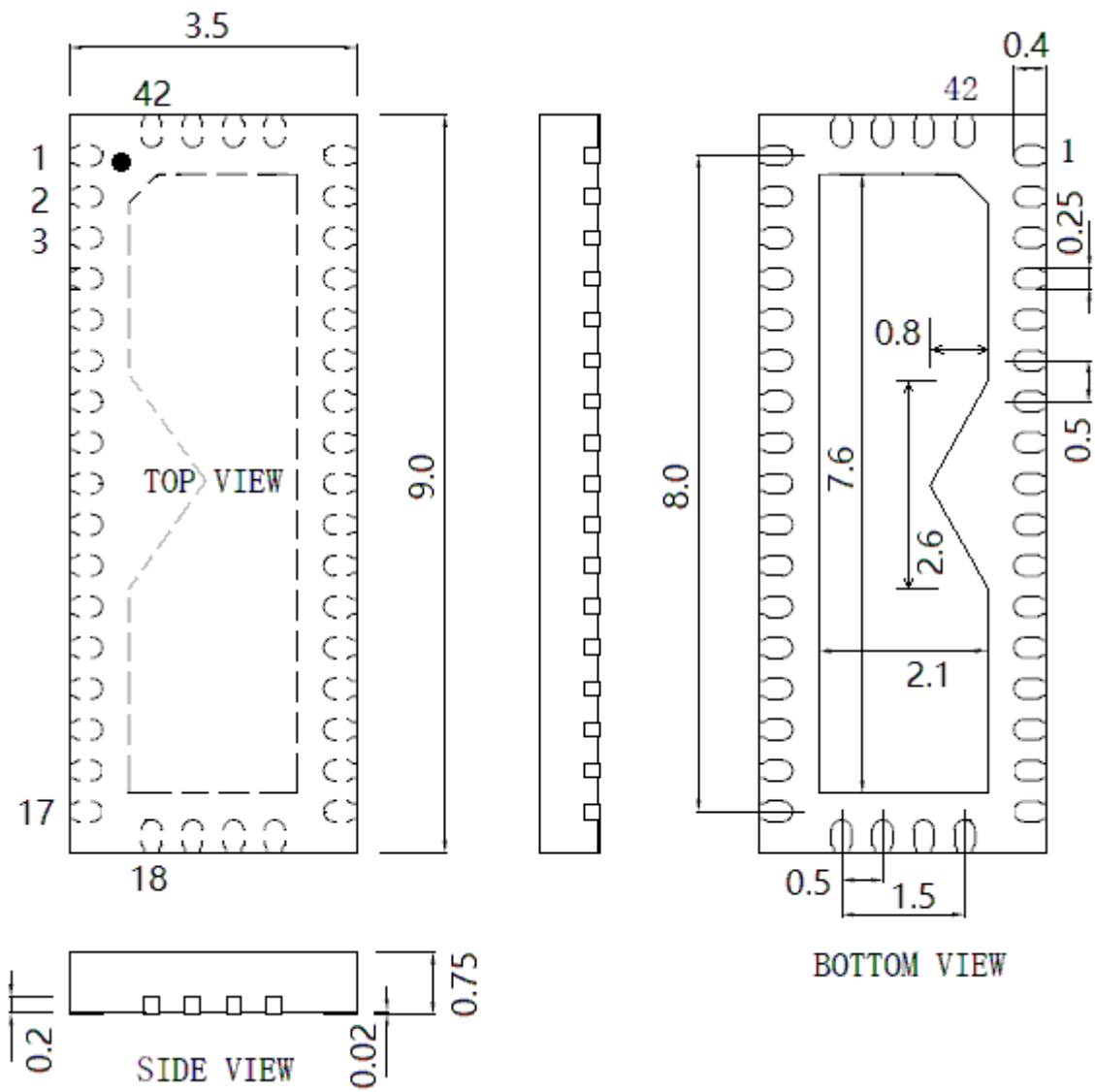

QFN48 (QFN48-5\*5)

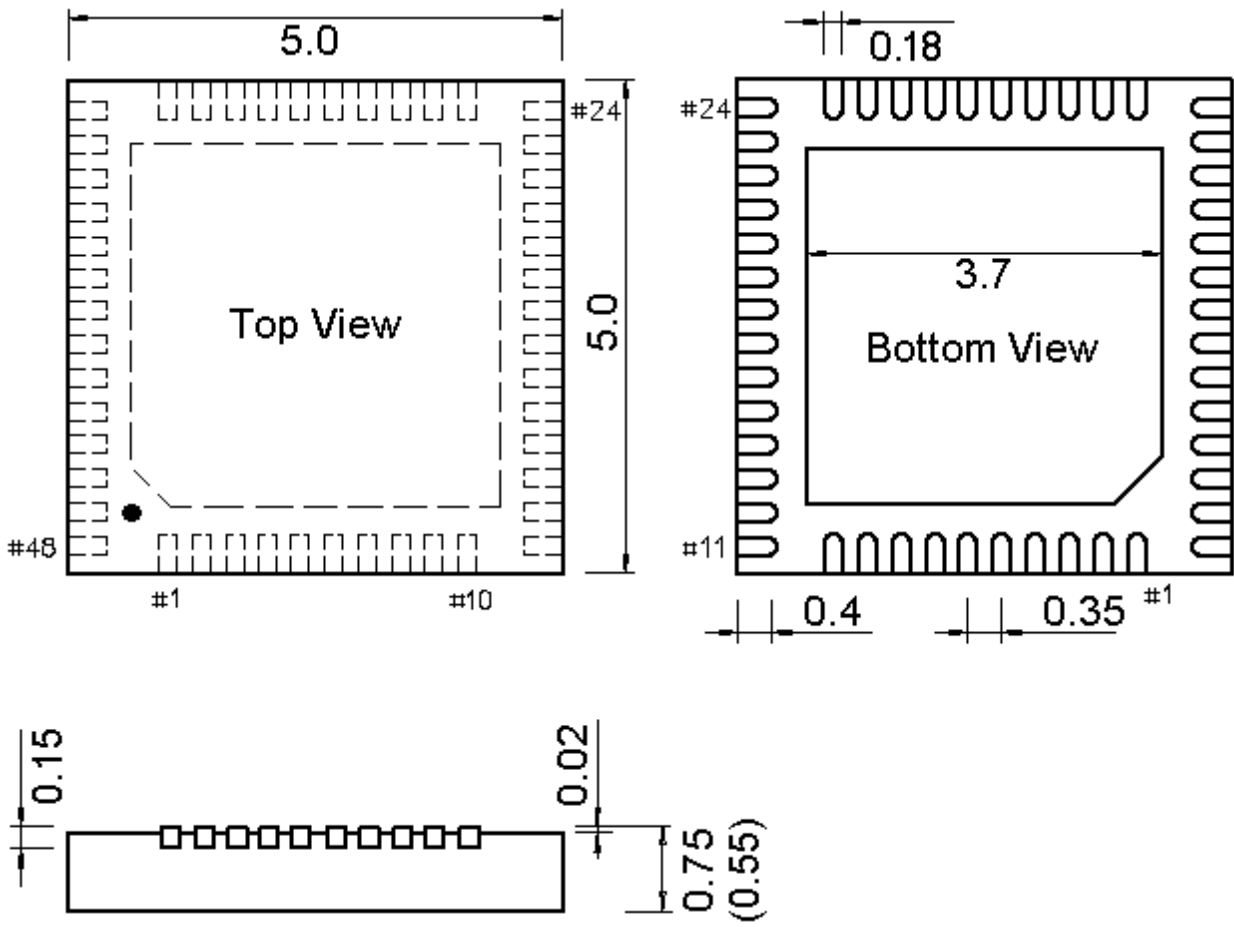

QFN48X6 (QFN48-6\*6)

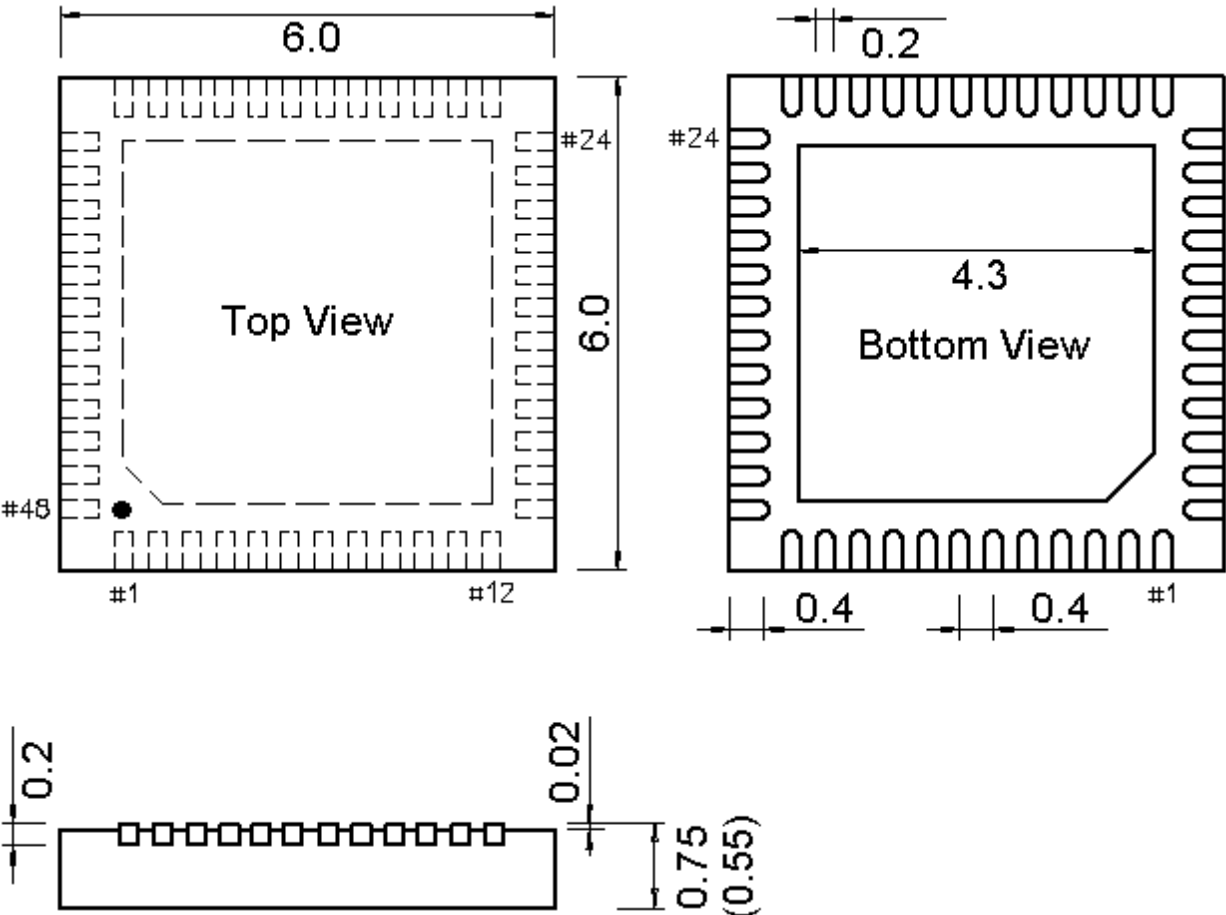

QFN48X7 (QFN48-7\*7)

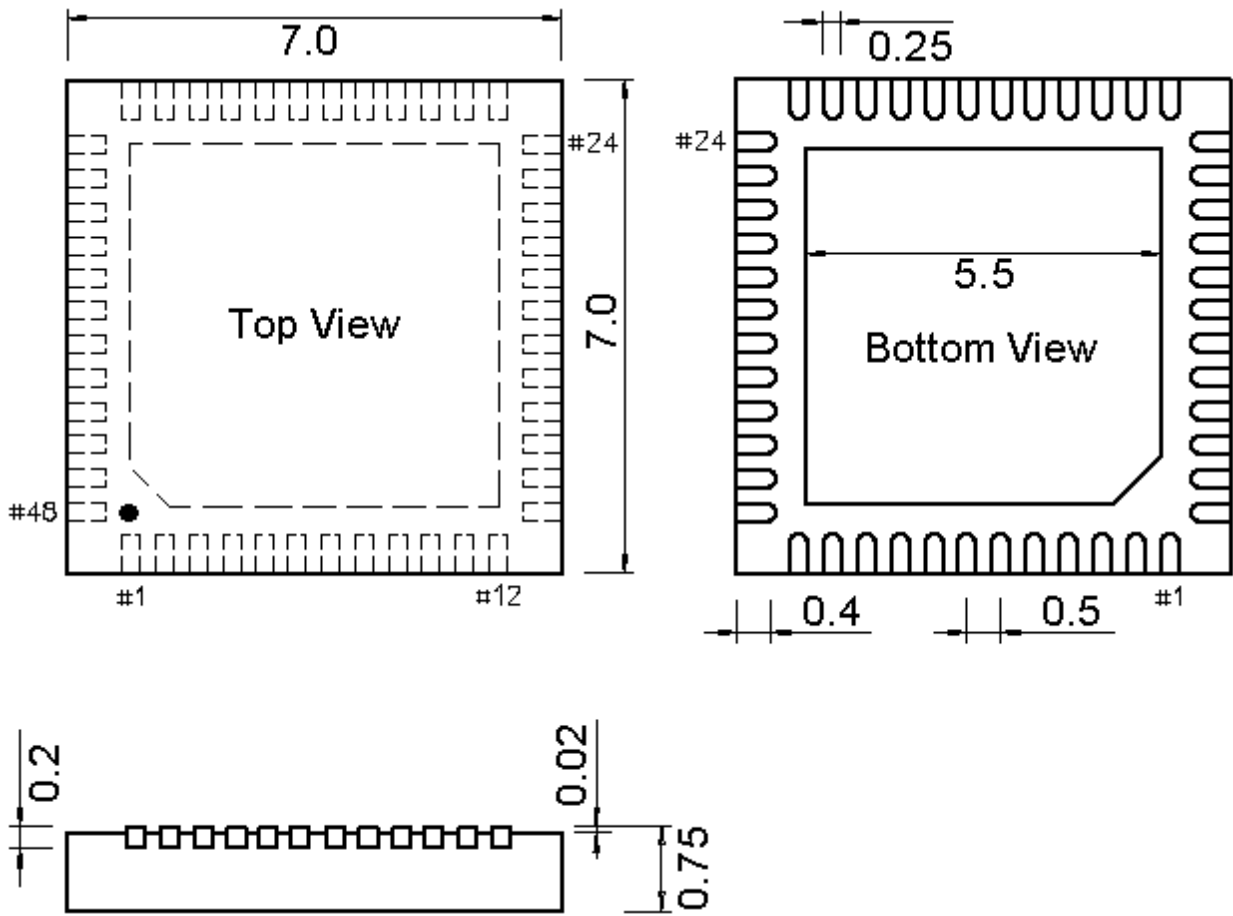

QFN68X8 (QFN68-8\*8)

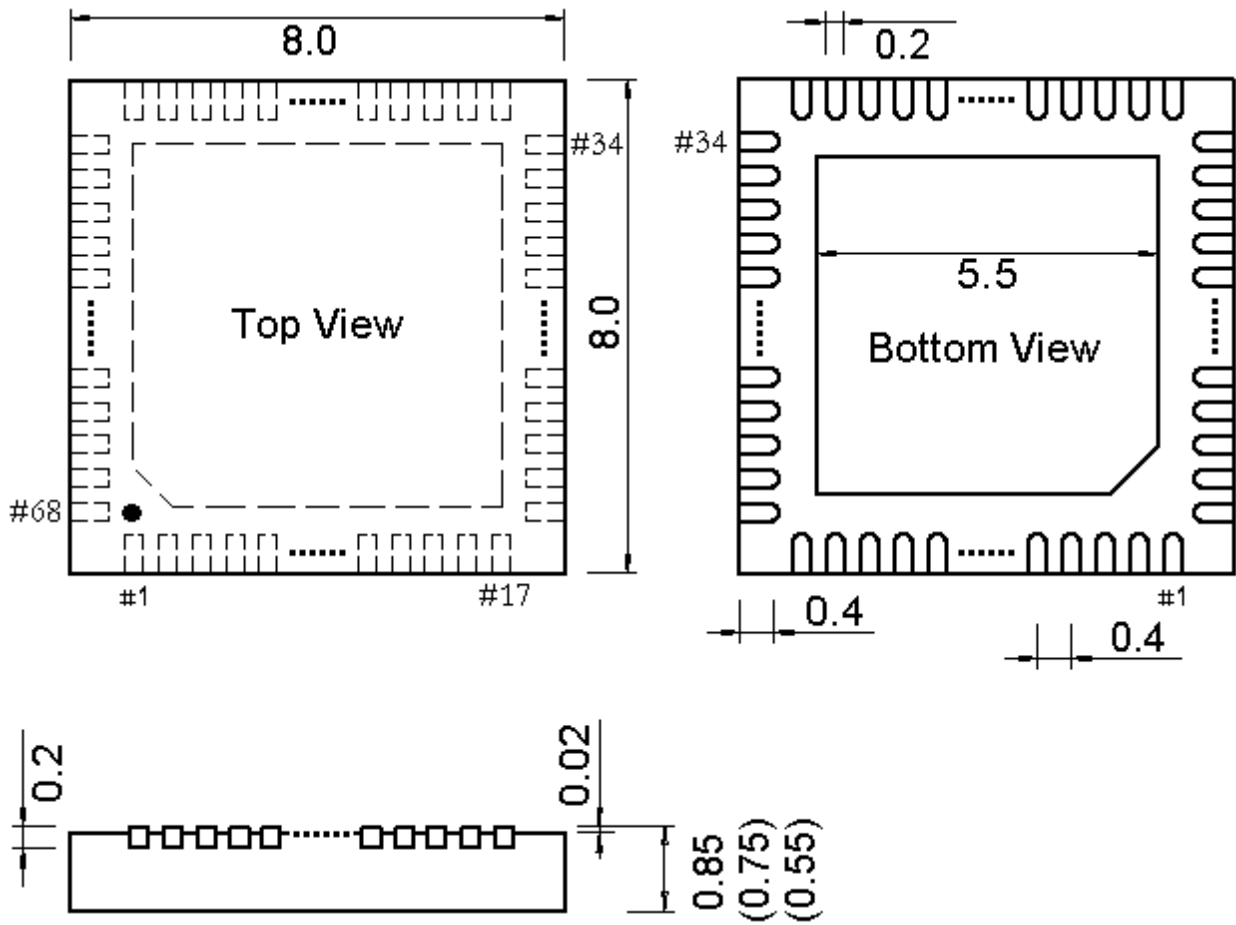

SOT 类

SOT23-6、TSOT23-6L

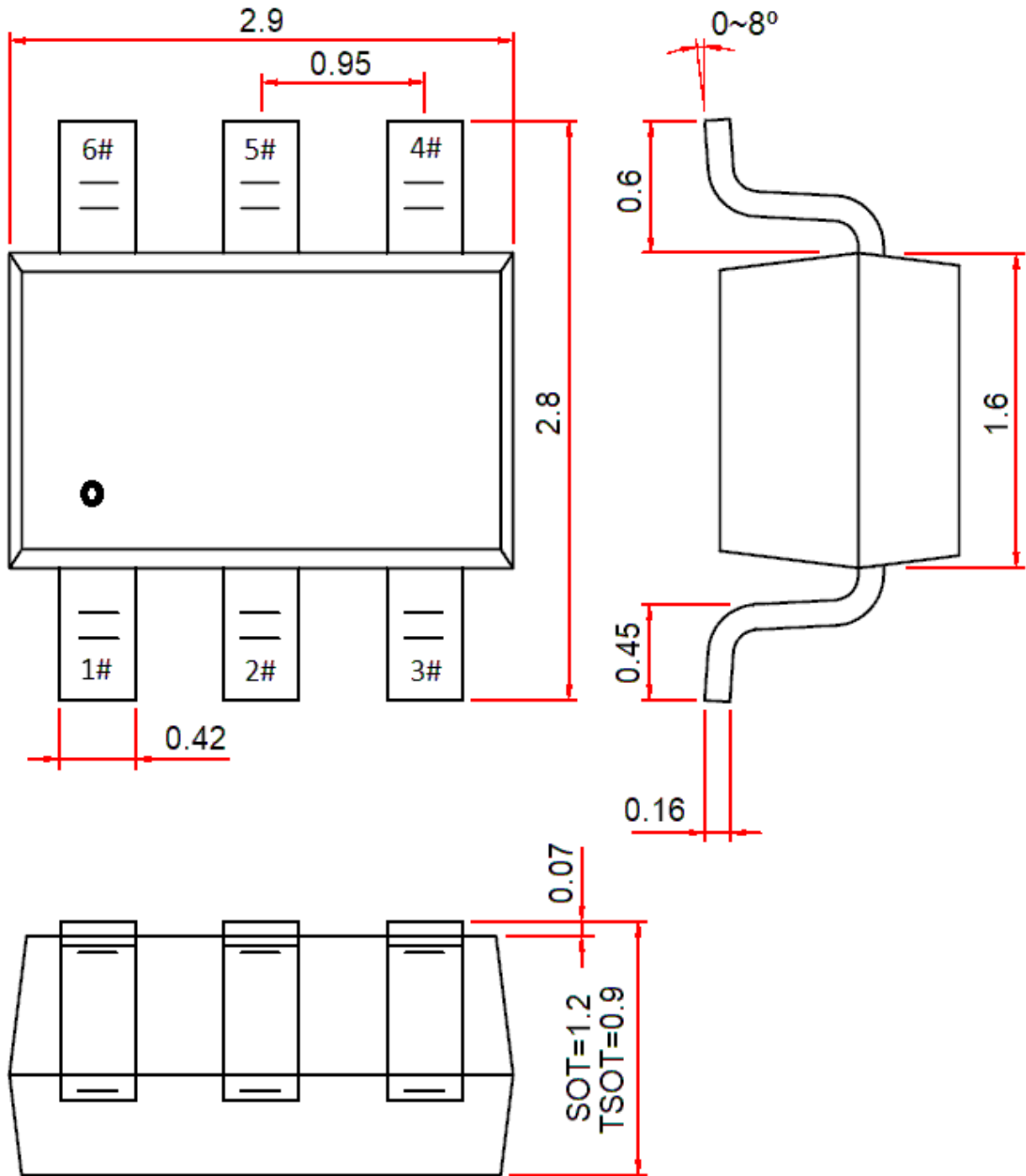

SOT23-8、TSOT23-8L

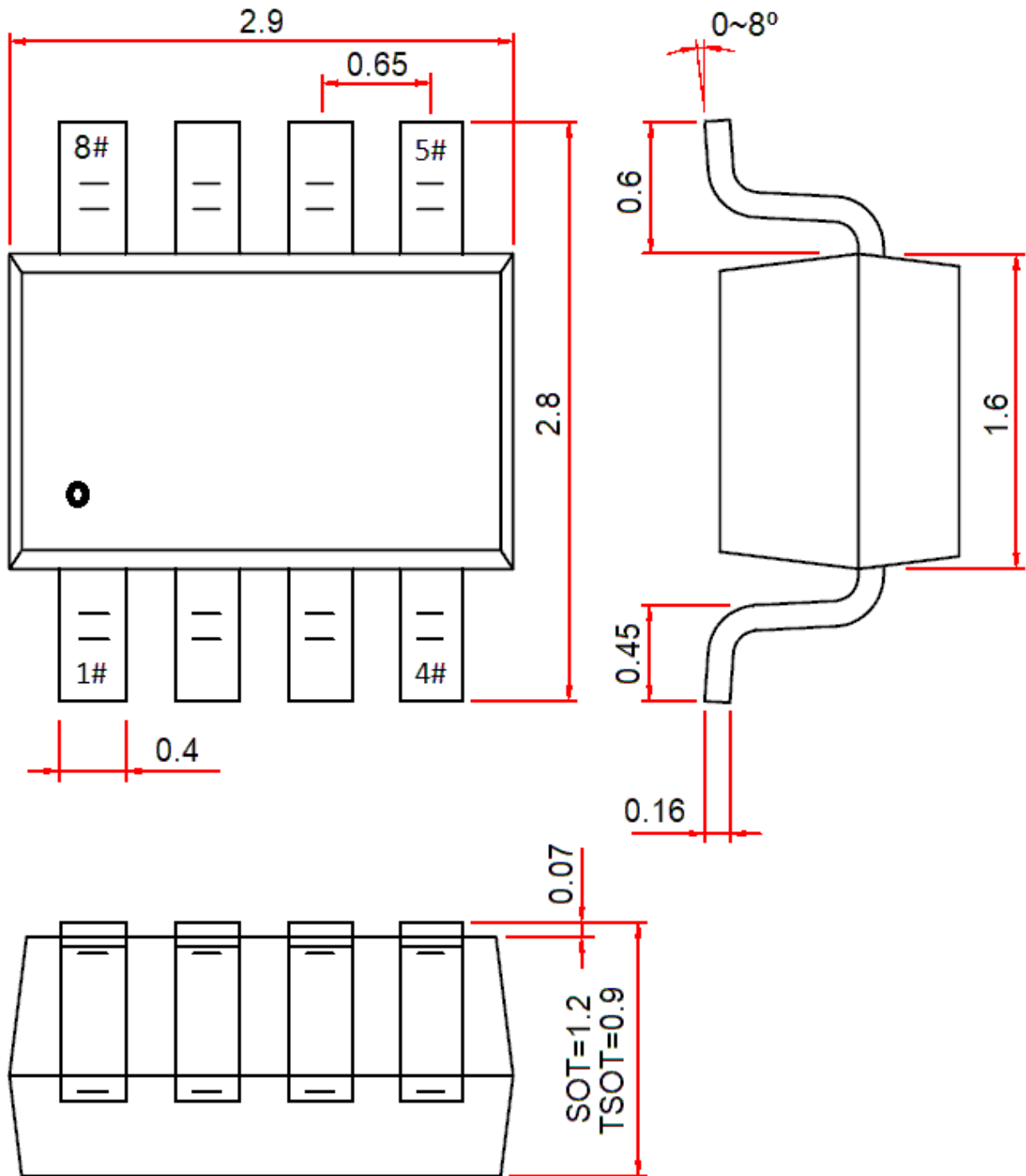

SOT363 (SC70-6L)

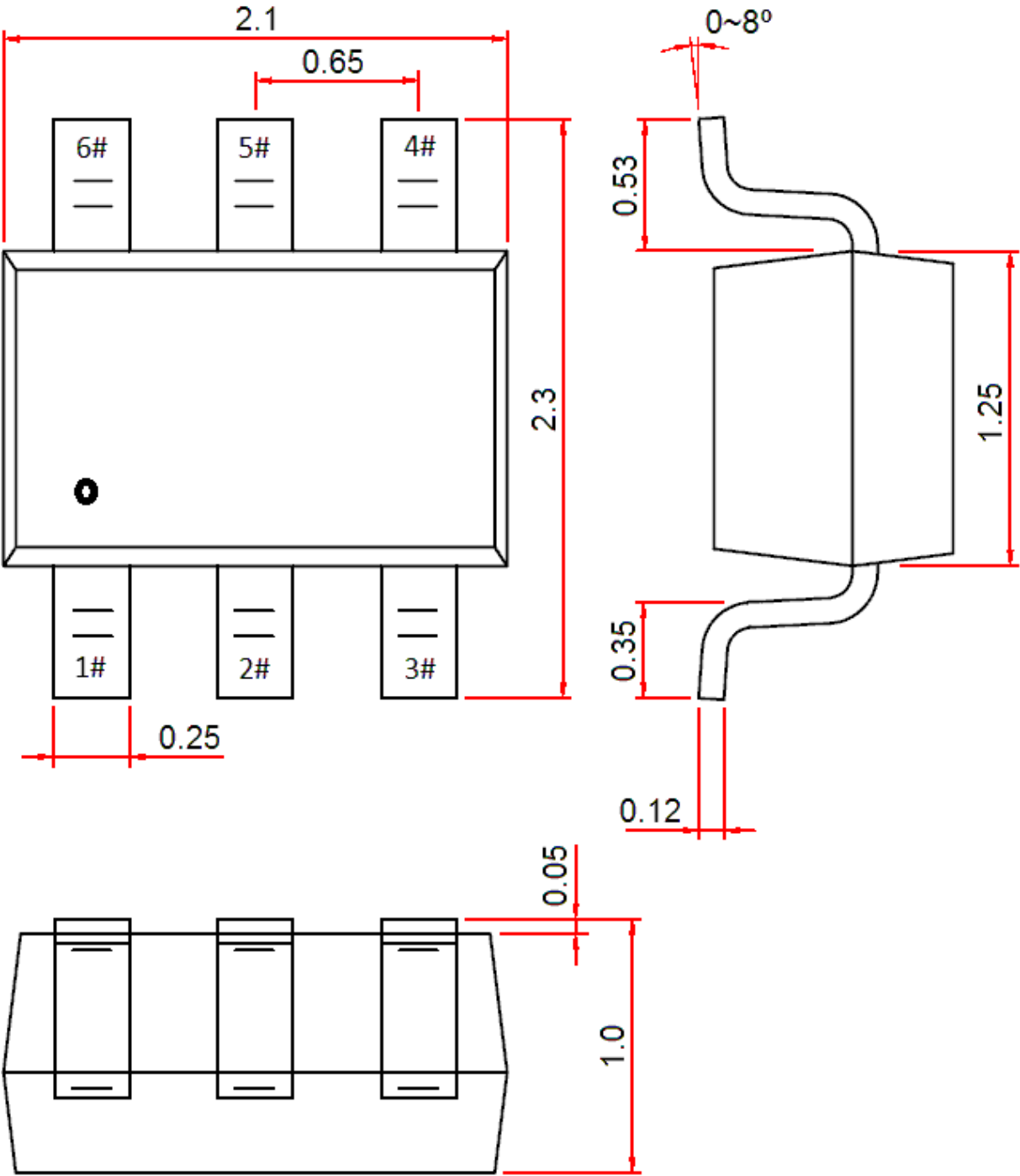



SOT353 (SC70-5L)

